

P10
INSIDE/OUTSIDE
CORNER

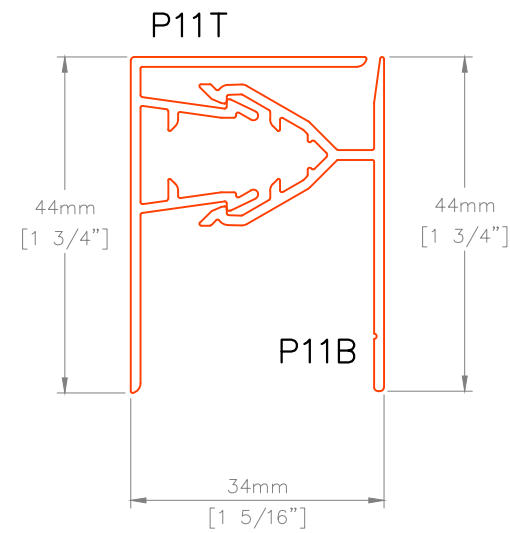

P11
2-PIECE J

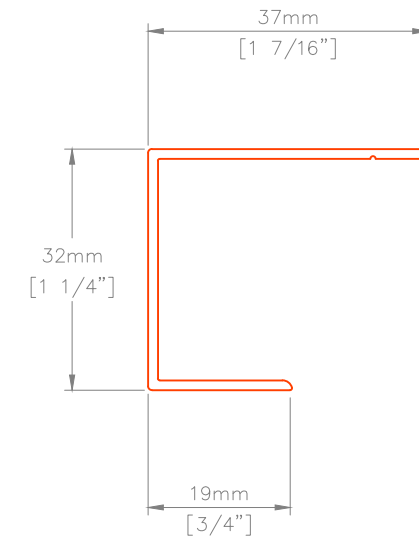

P13
GENERAL J

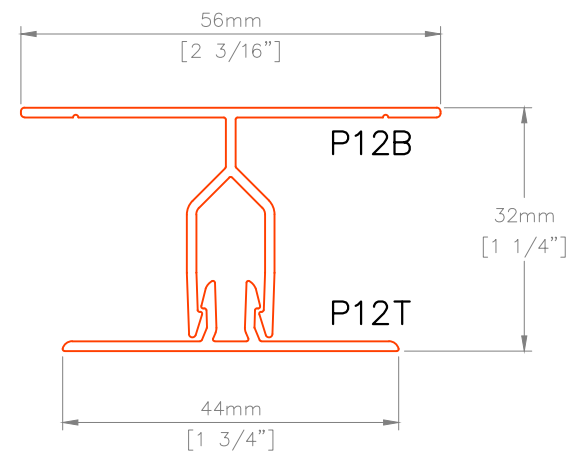

P12
2-PIECE VERTICAL

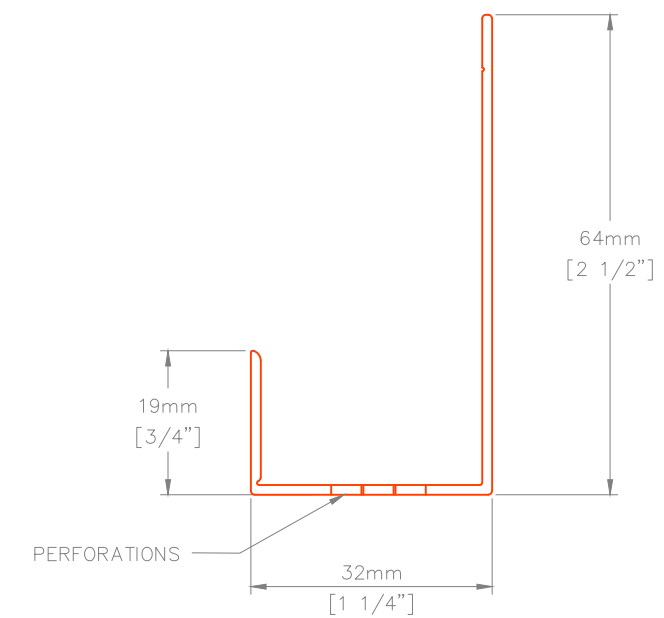

P41
PERFORATED STARTER J

ALL TRIM APPROX. 1.30mm [.051\"] ~16 ga

Copyright © 2024 EasyTrim Reveals®. All rights reserved.

	DESCRIPTION		
	PROFILE DETAILS 1of4		
	SCALE	NTS	DRAWING NUMBER
	DATE	FEB2024	FPO.1
	DRWN BY	HJ/DDG	

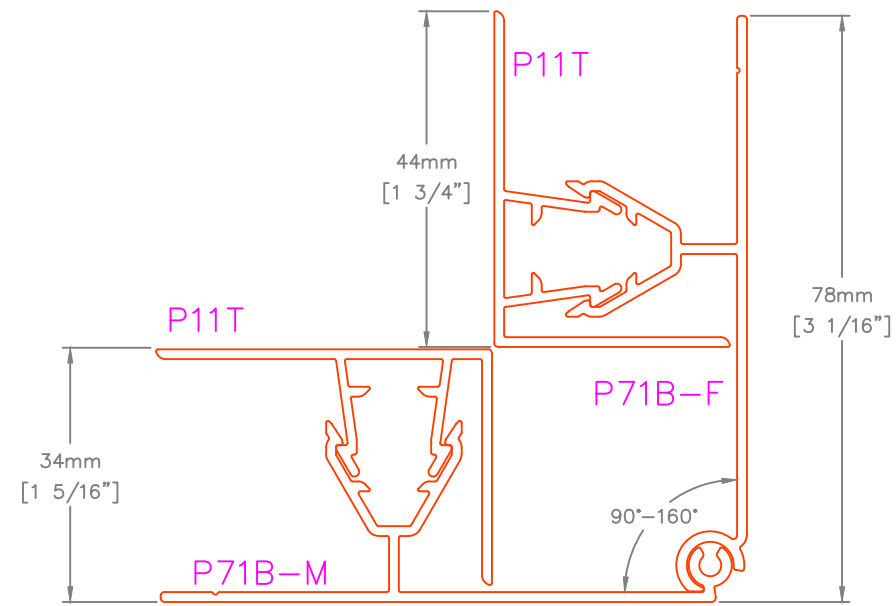

P71
ADJUSTABLE INSIDE
CORNER

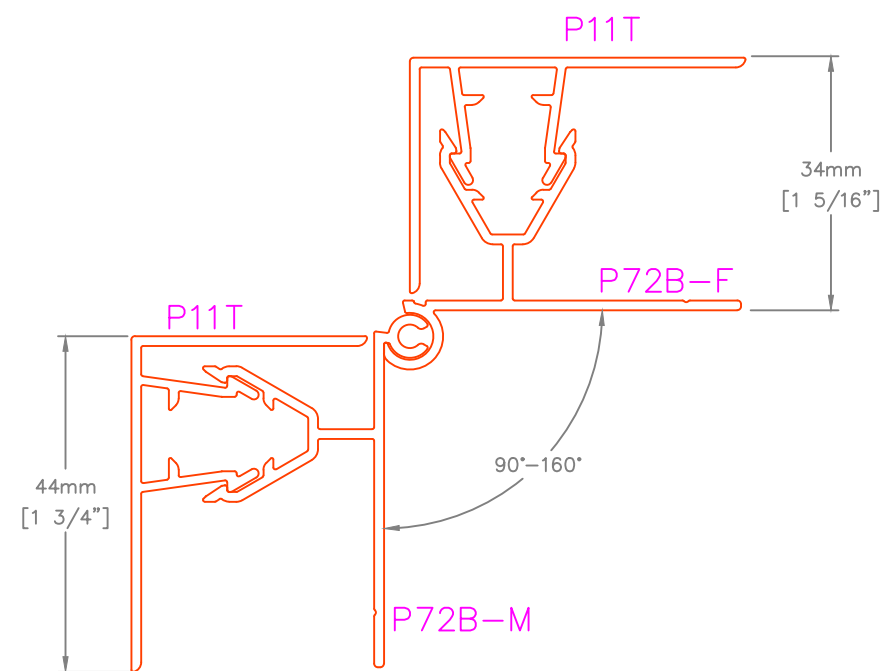

P72
ADJUSTABLE OUTSIDE
CORNER

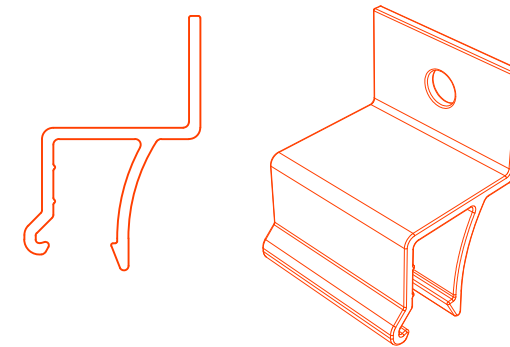

P22
PLANK CLIP

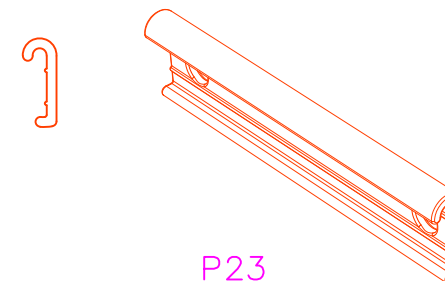

P23
PLANK CONNECTOR

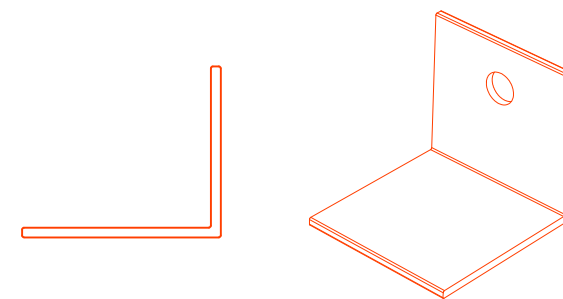

P30
PLANK BACKER

ALL TRIM APPROX. 1.30mm [.051"] ~16 ga

Copyright © 2024 EasyTrim Reveals®. All rights reserved.

ENGAGE
BUILDING PRODUCTS™

DESCRIPTION			
PROFILE DETAILS 2of4			
SCALE	NTS	DRAWING NUMBER	
DATE	FEB2024	FP0.2	
DRWN BY	HJ/DDG		

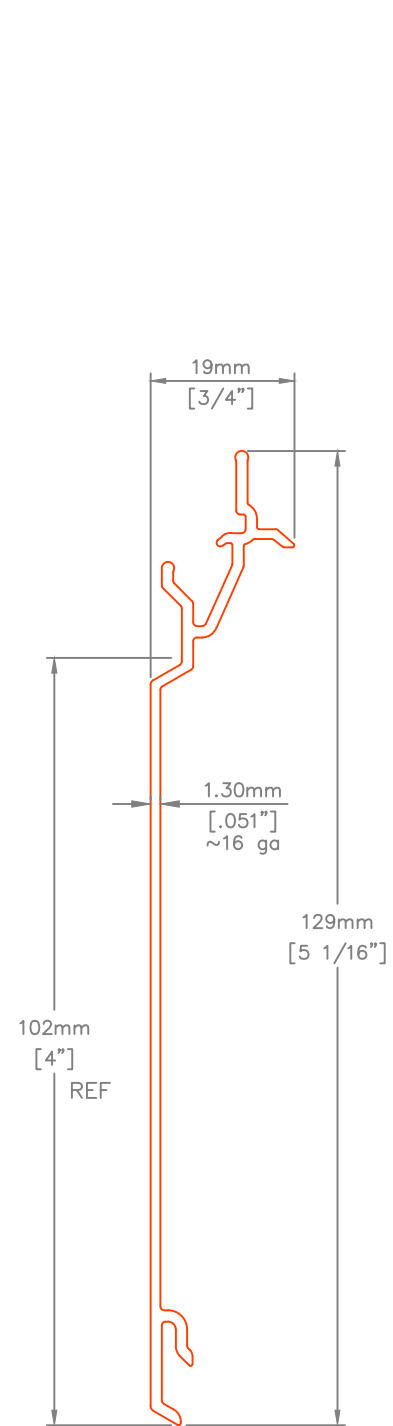

P44V
V-NOTCH 4"
PLANK

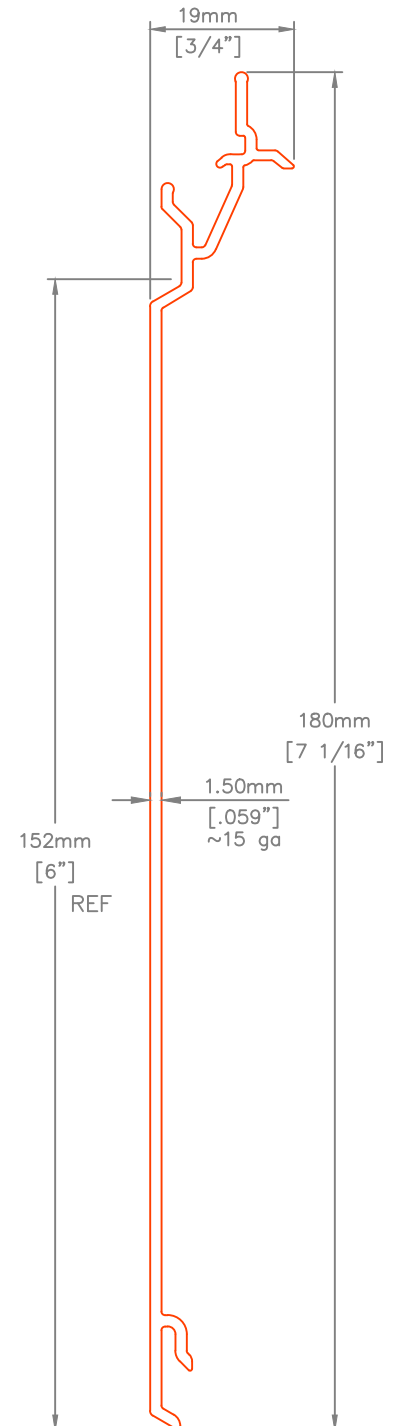

P46V
V-NOTCH 6"
PLANK

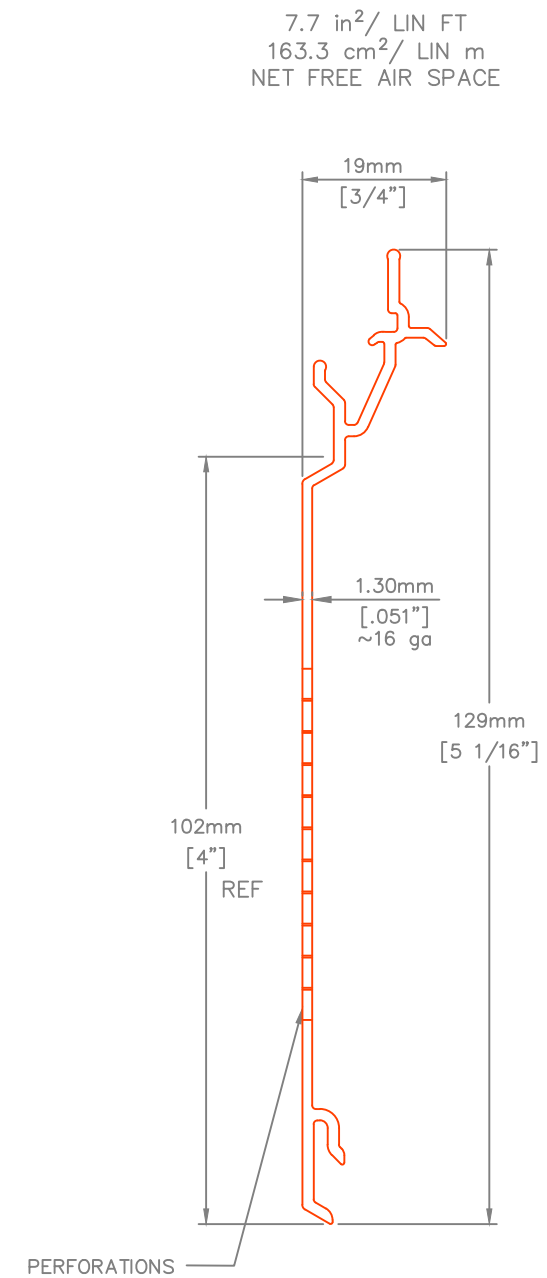

P47V
V-NOTCH SOFFIT
PLANK

	DESCRIPTION		
	PROFILE DETAILS 3of4		
	SCALE	NTS	DRAWING NUMBER
	DATE	FEB2024	FP0.3
	DRWN BY	HJ/DDG	

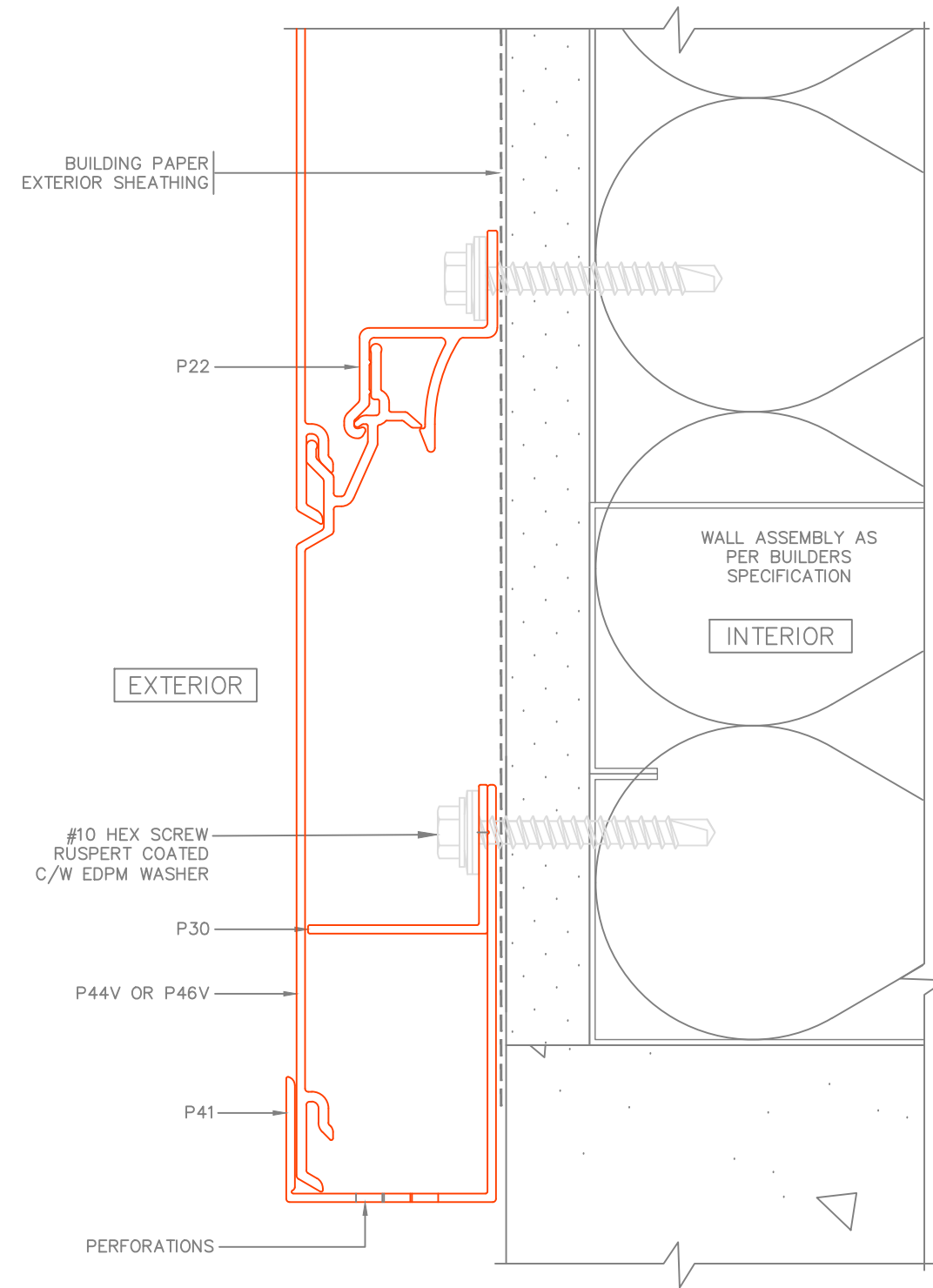

	DESCRIPTION		
	PERFORATED STARTER J TRIM		
	SCALE	NTS	DRAWING NUMBER
	DATE	FEB2024	FP1.1
	DRWN BY	HJ/DDG	

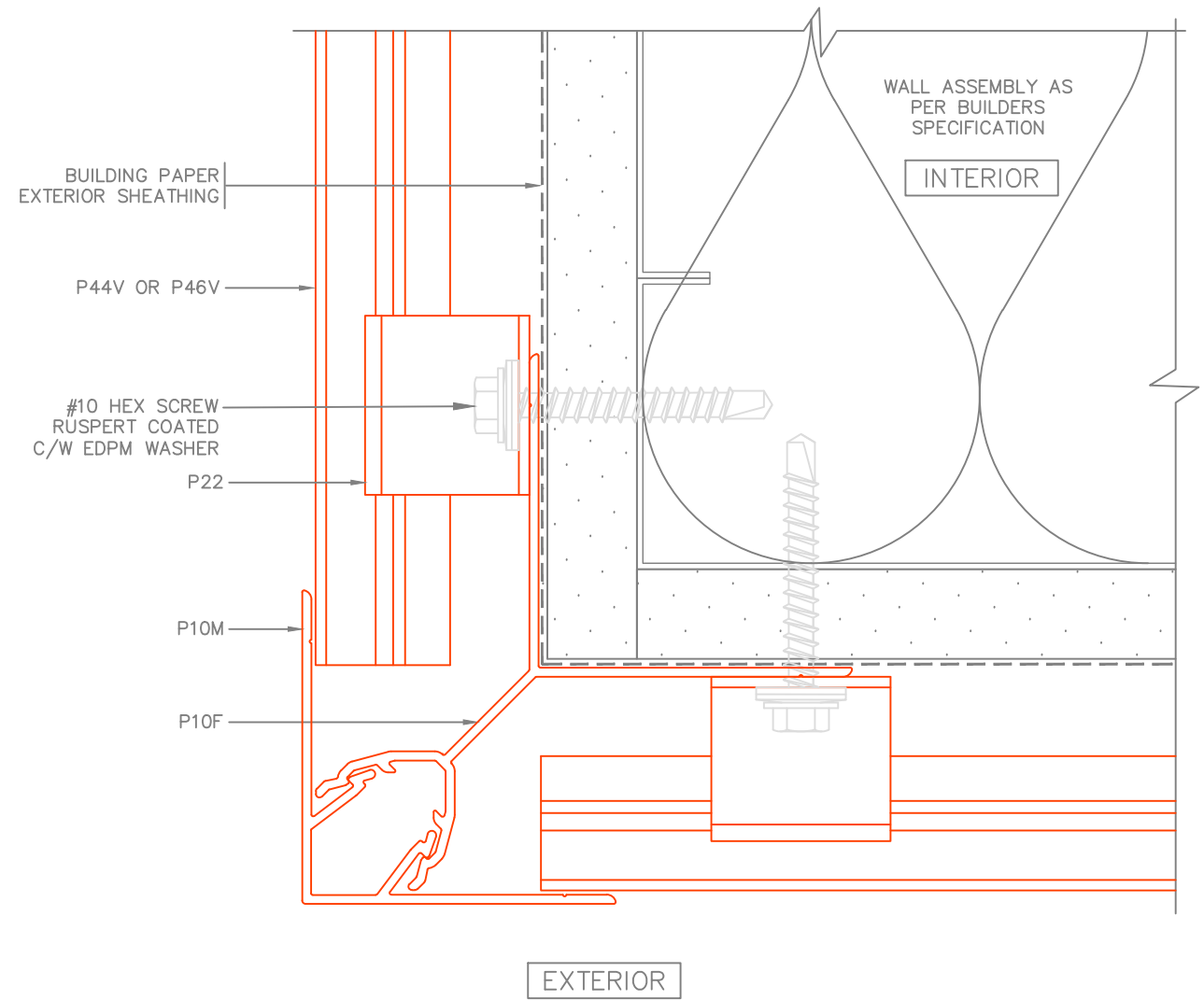
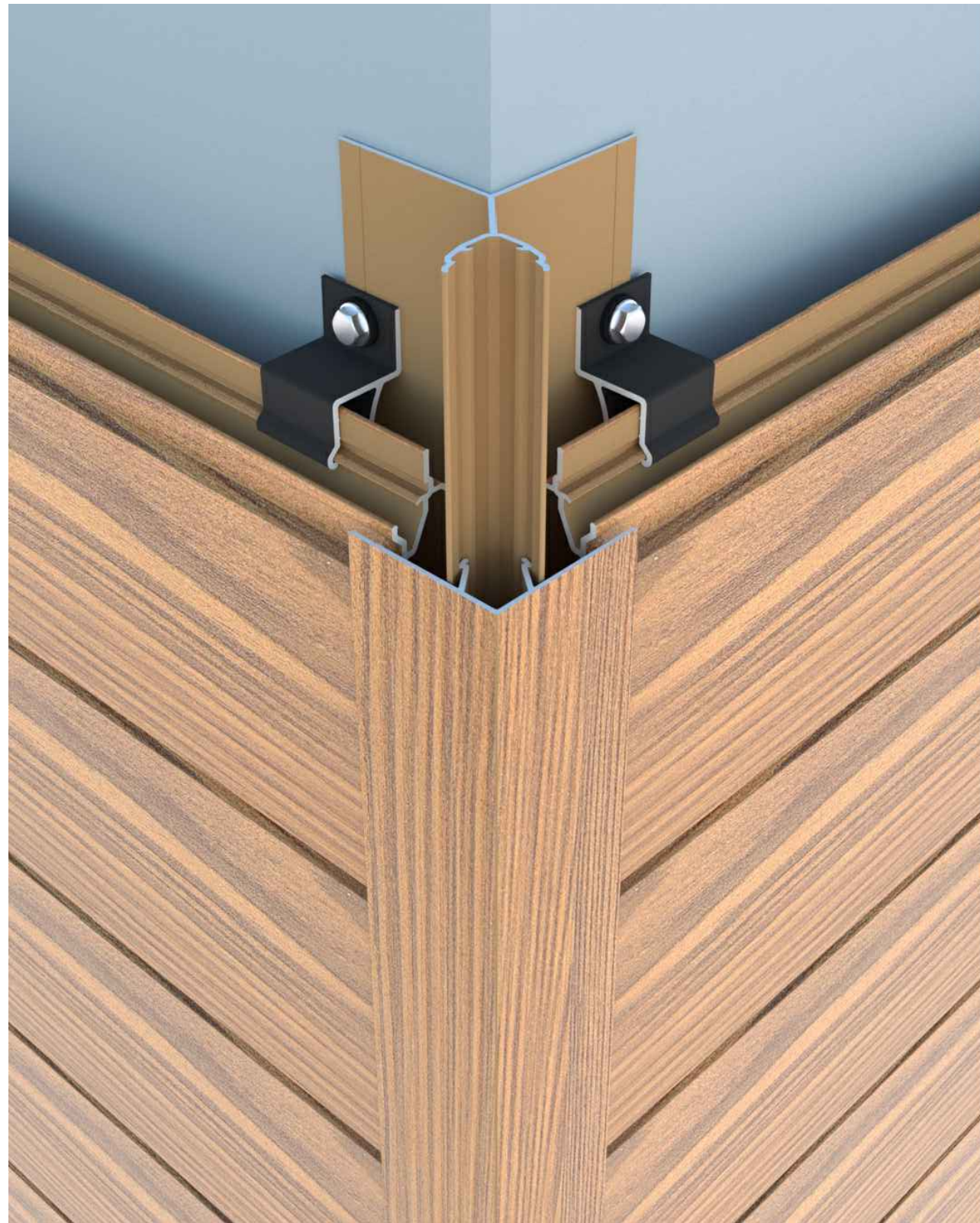

	DESCRIPTION			OUTSIDE CORNER TRIM	
	SCALE	NTS	DRAWING NUMBER		
	DATE	FEB2024	FP1.2a		
	DRWN BY	HJ/DDG			

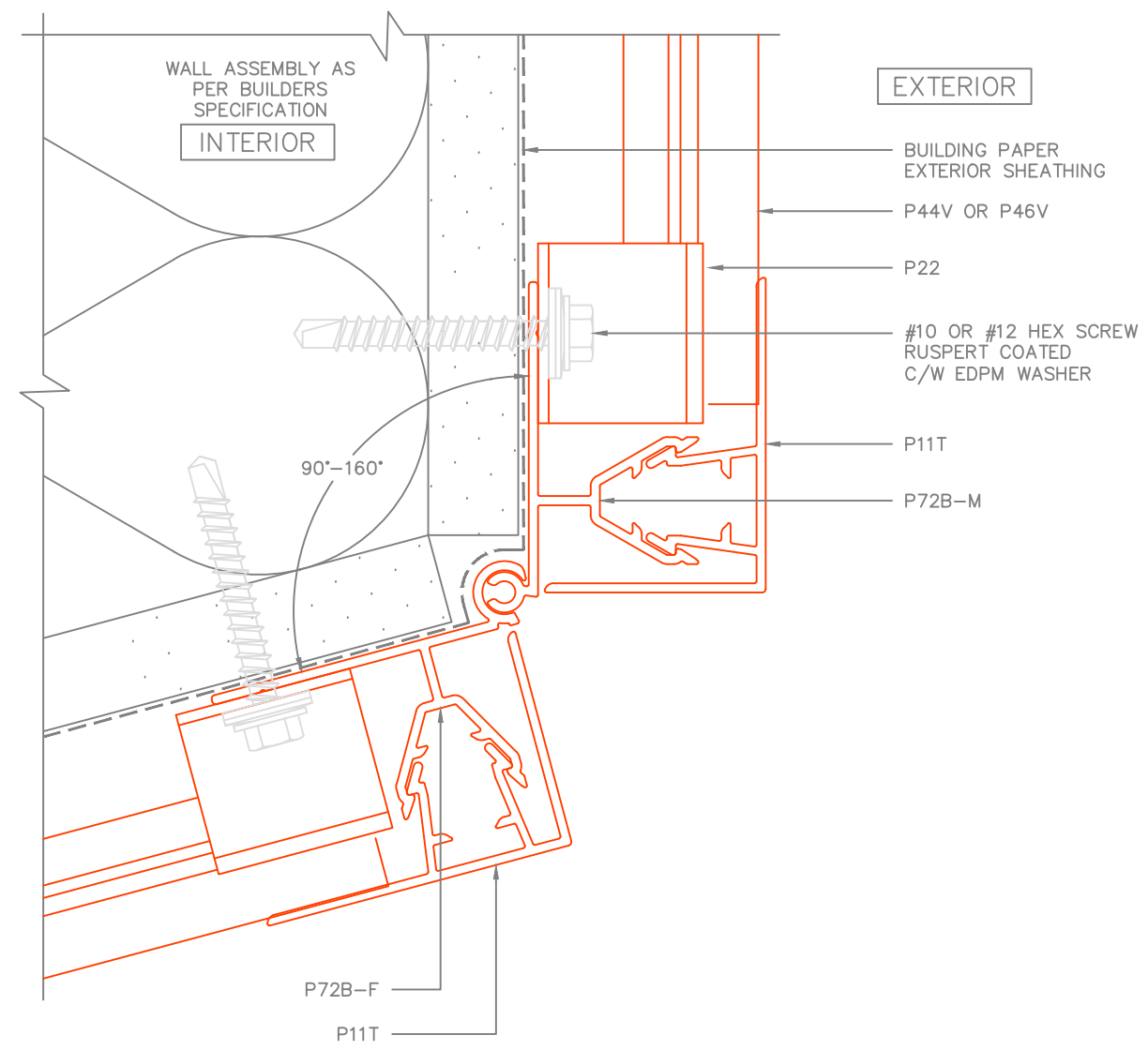
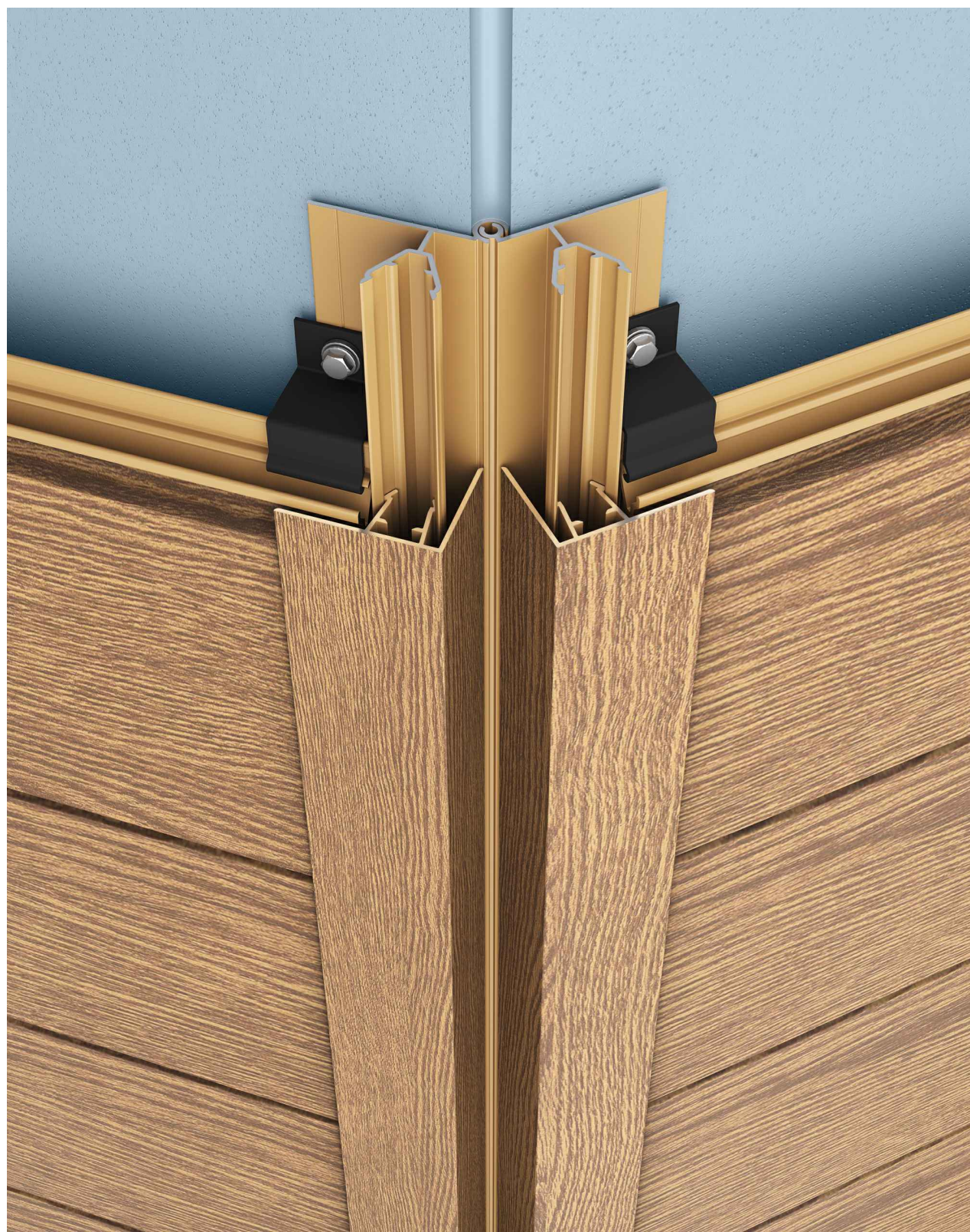

	DESCRIPTION			MULTI-ANGLE OUTSIDE CORNER TRIM	
	SCALE	NTS	DRAWING NUMBER		
	DATE	DEC2024	FP1.2b		
	DRWN BY	DLR			

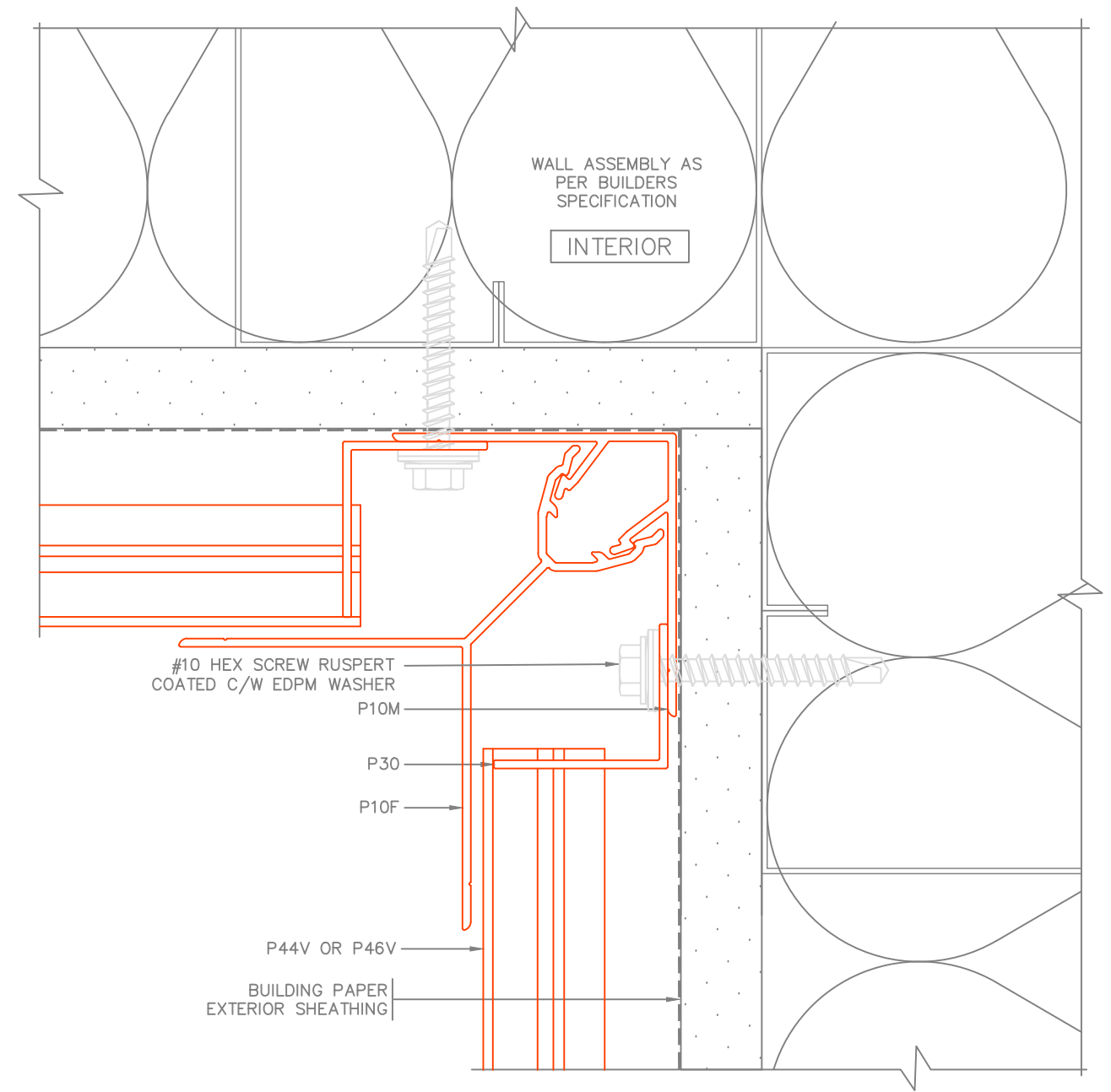
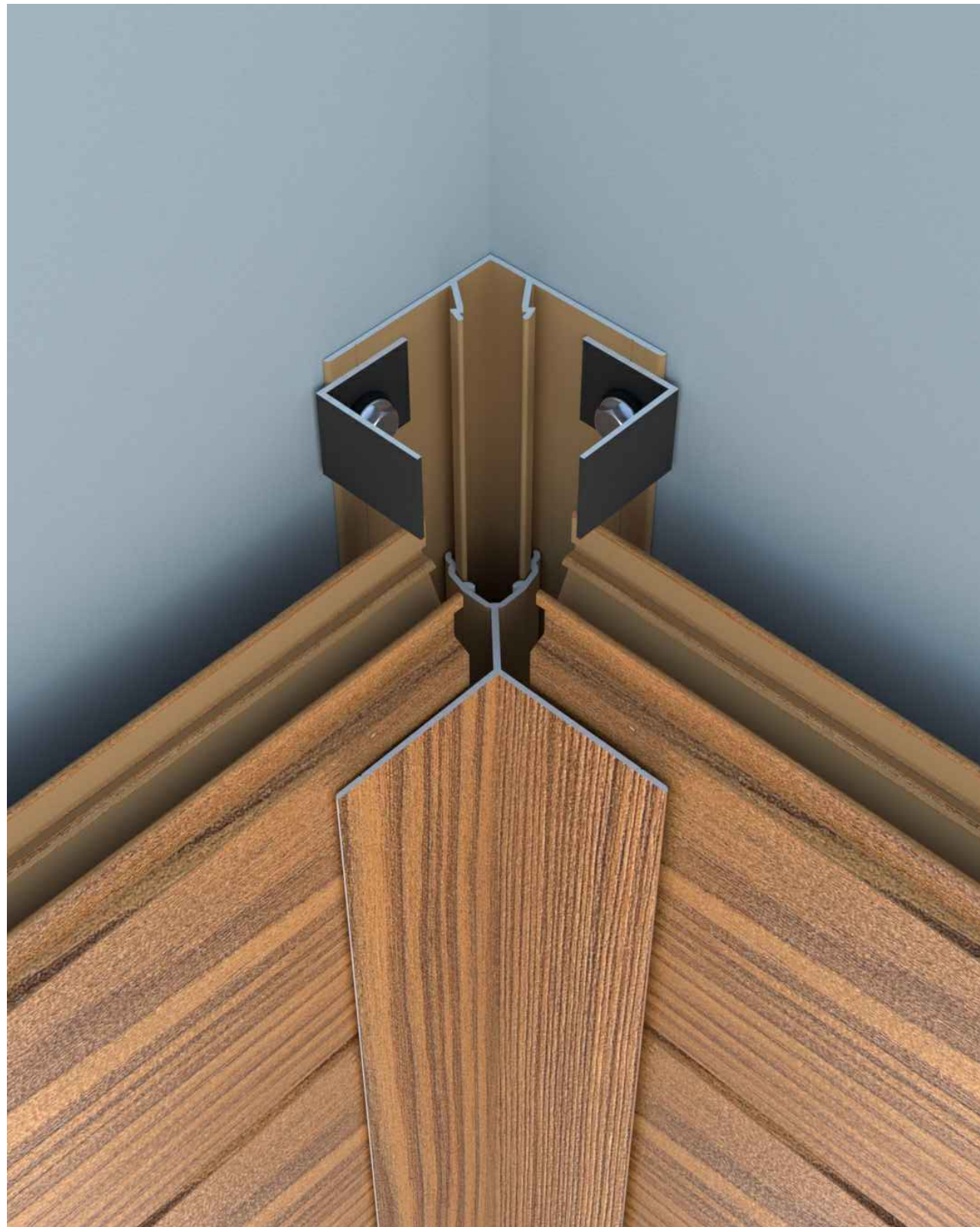

	DESCRIPTION		
	INSIDE CORNER TRIM		
	SCALE	NTS	DRAWING NUMBER
	DATE	FEB2024	FP1.3a
	DRWN BY	HJ/DDG	

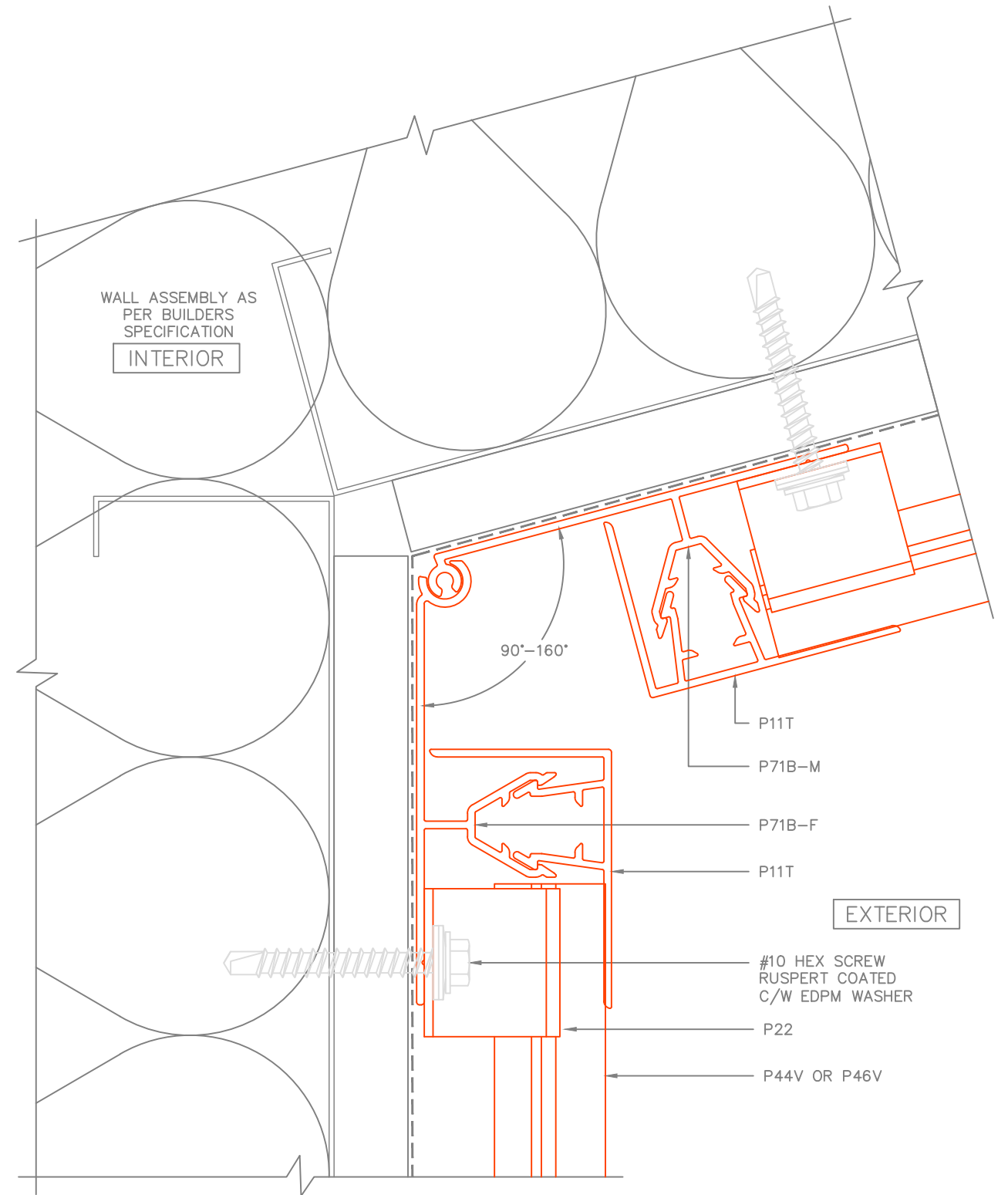
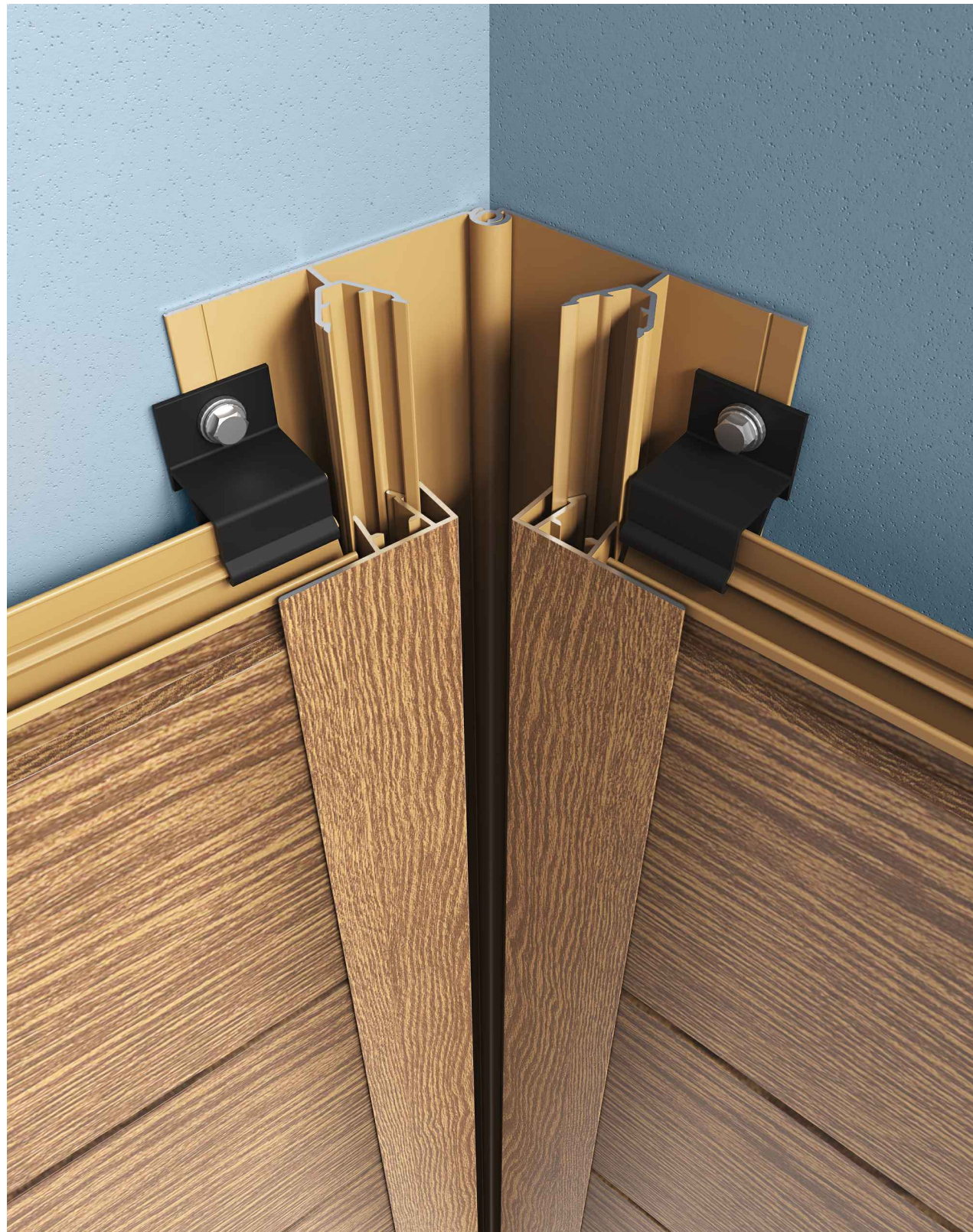

	DESCRIPTION		
	MULTI-ANGLE INSIDE CORNER TRIM		
	SCALE	NTS	DRAWING NUMBER
	DATE	DEC2024	FP1.3b
	DRWN BY	DLR	

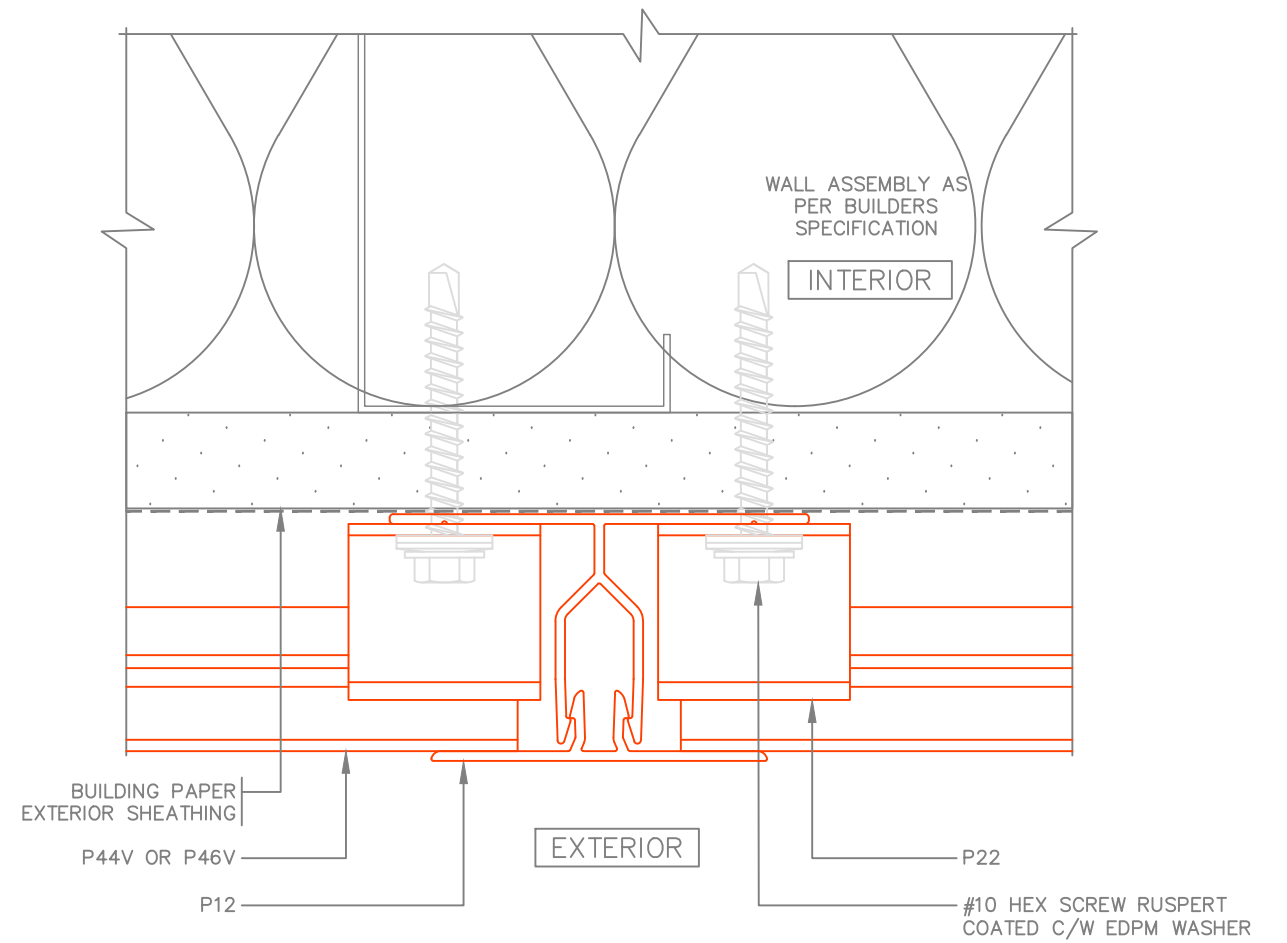

	DESCRIPTION			2-PIECE VERTICAL TRIM	
	SCALE	NTS	DRAWING NUMBER		
	DATE	FEB2024	FP1.4		
	DRWN BY	HJ/DDG			

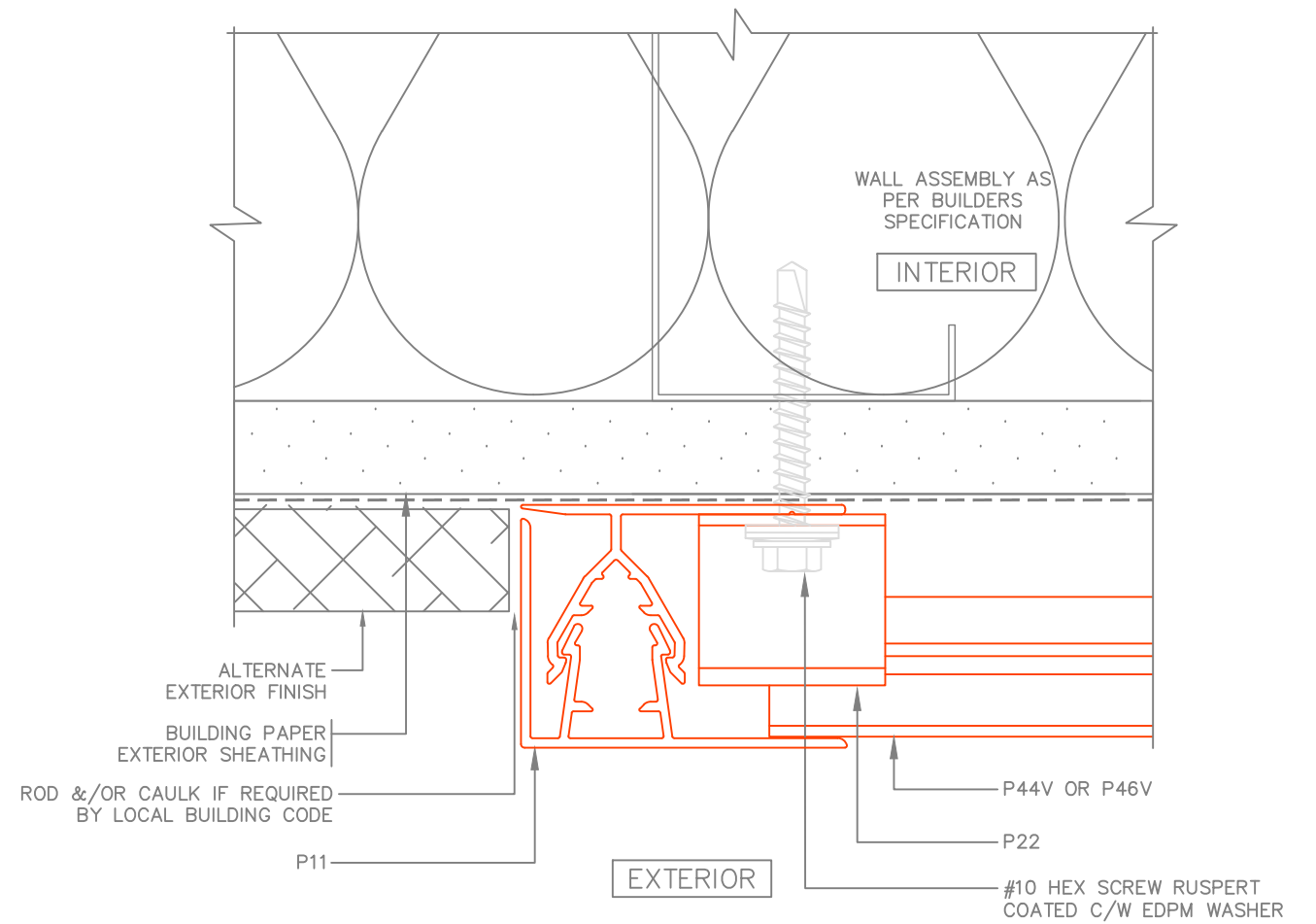

DESCRIPTION			2-PIECE J VERTICAL TERMINATION	
SCALE	NTS	DRAWING NUMBER		
DATE	FEB2024	FP1.5a		
DRWN BY	HJ/DDG			

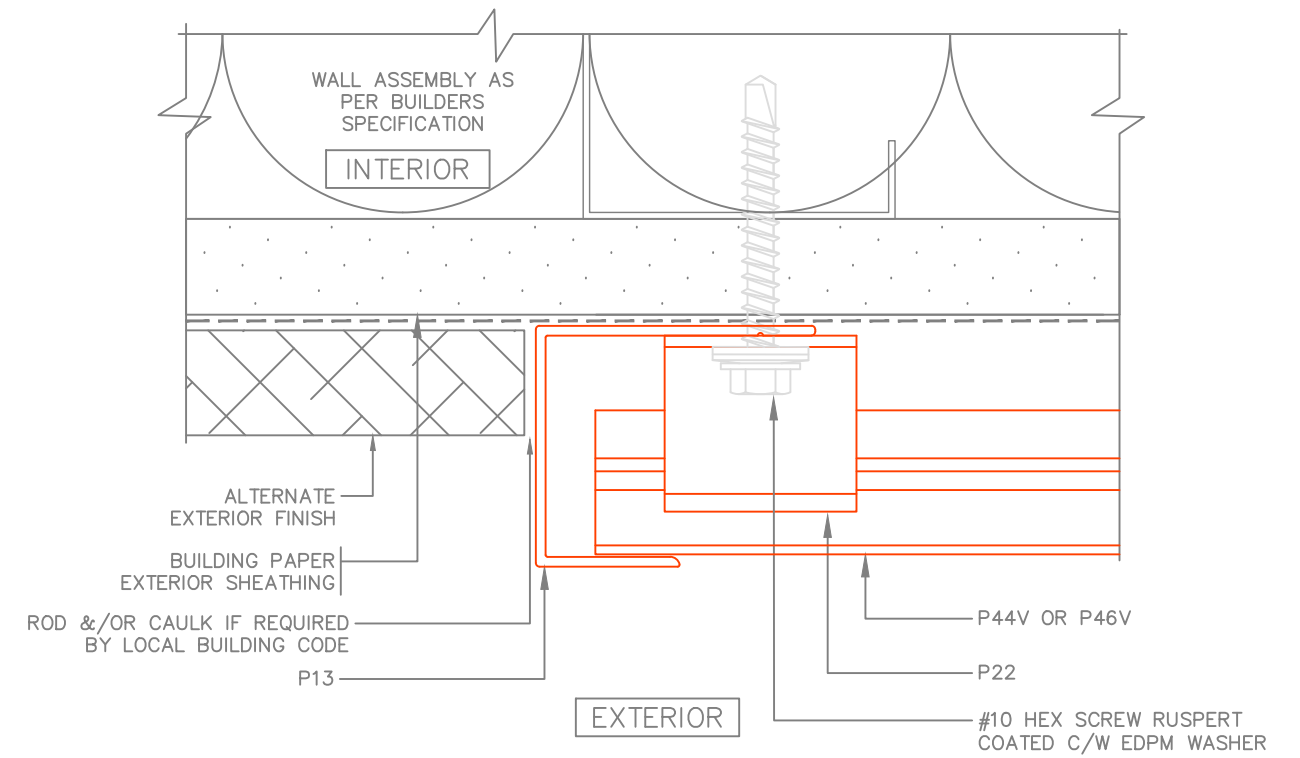
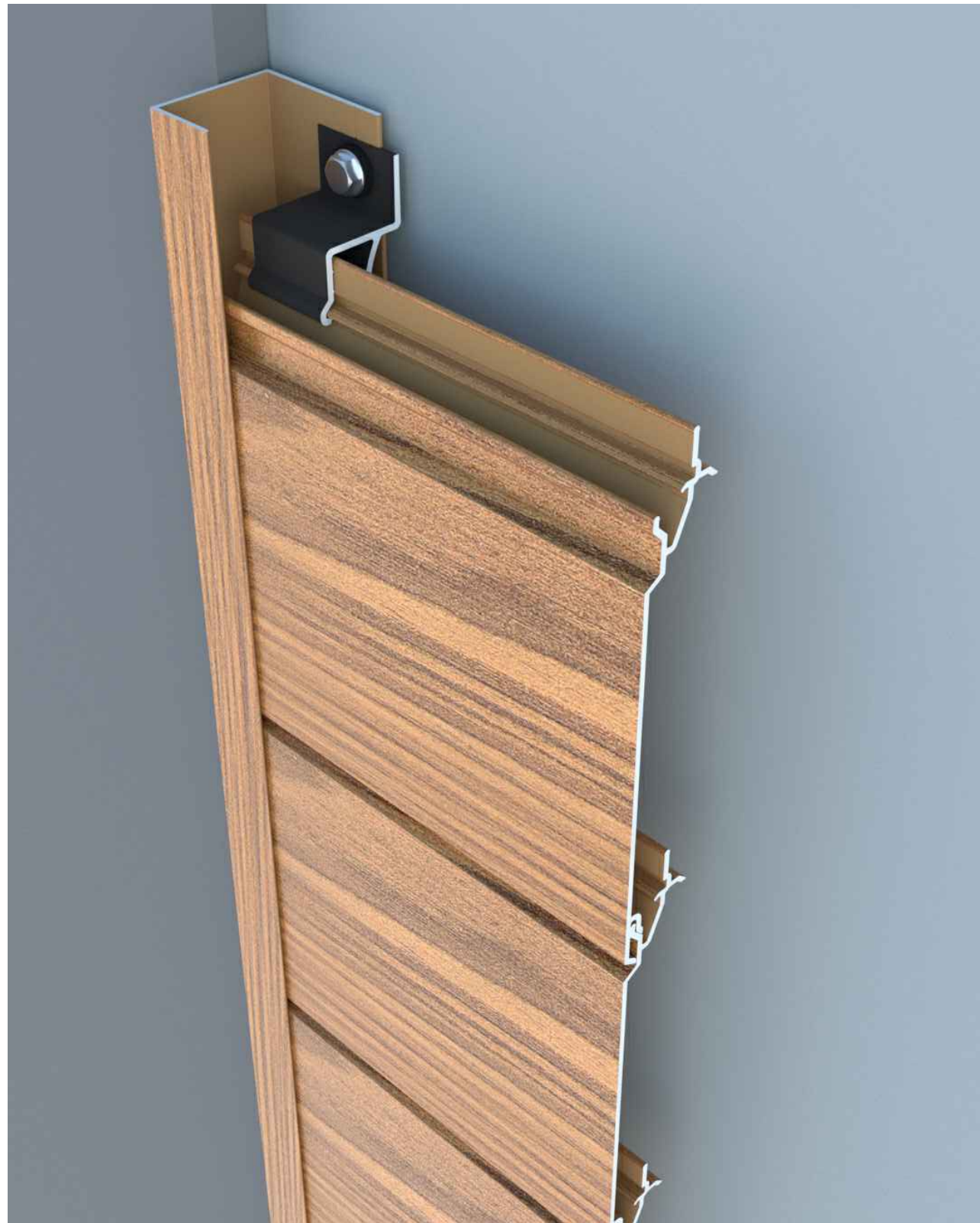

	DESCRIPTION			GENERAL J VERTICAL TERMINATION	
	SCALE	NTS	DRAWING NUMBER		
	DATE	FEB2024	FP1.5b		
	DRWN BY	HJ/DDG			

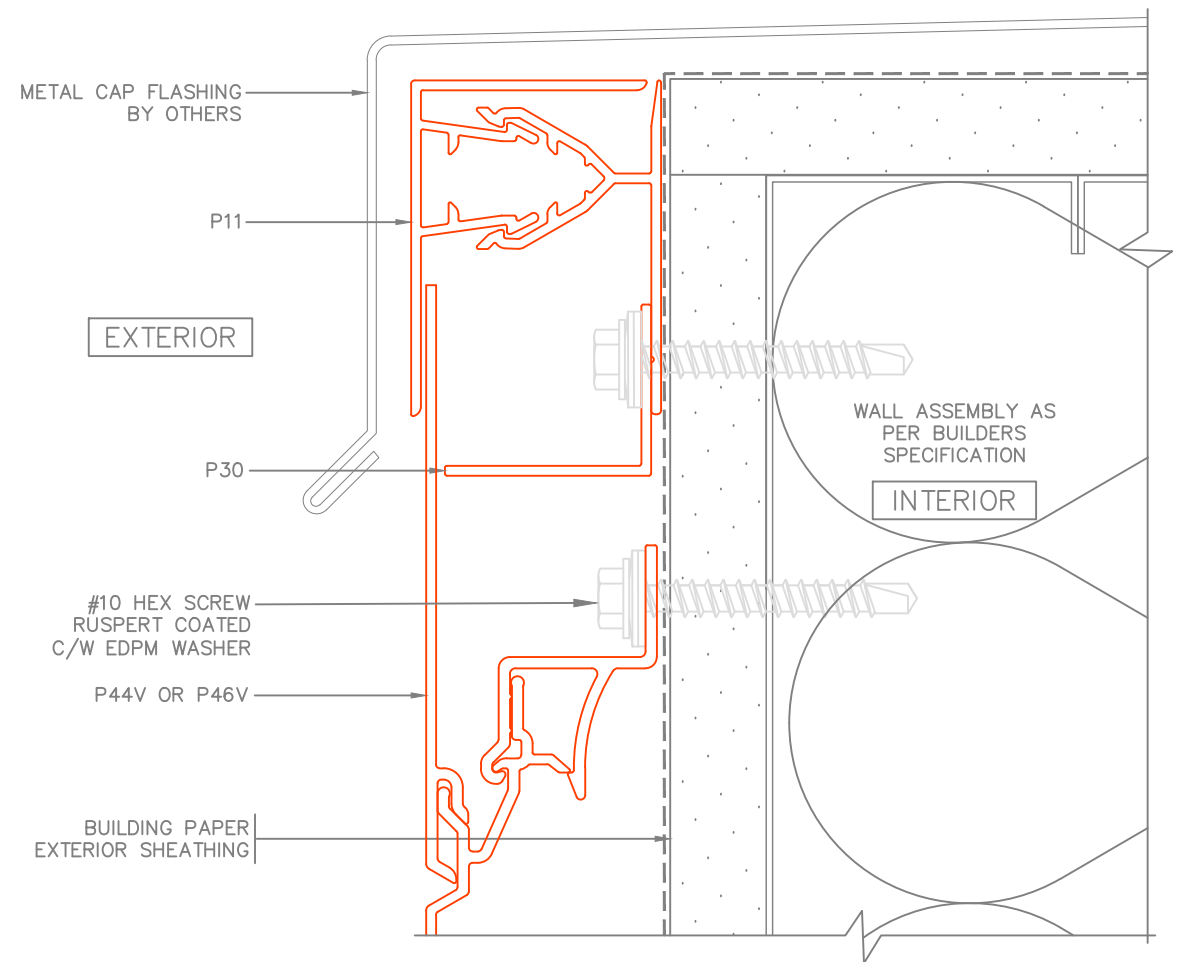
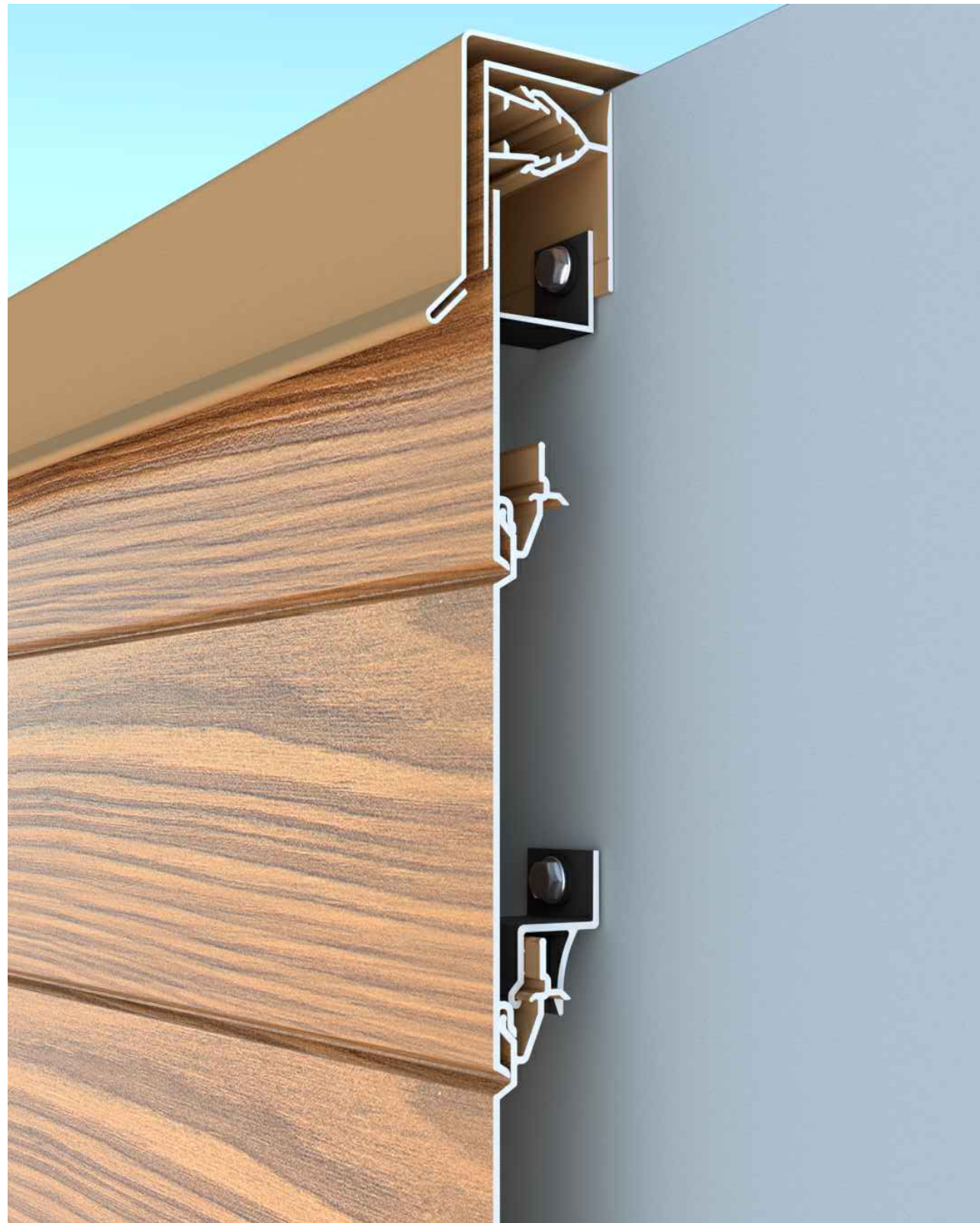

DESCRIPTION			
2-PIECE J PARAPET			
SCALE	NTS	DRAWING NUMBER	
DATE	FEB2024	FP1.6a	
DRWN BY	HJ/DDG		

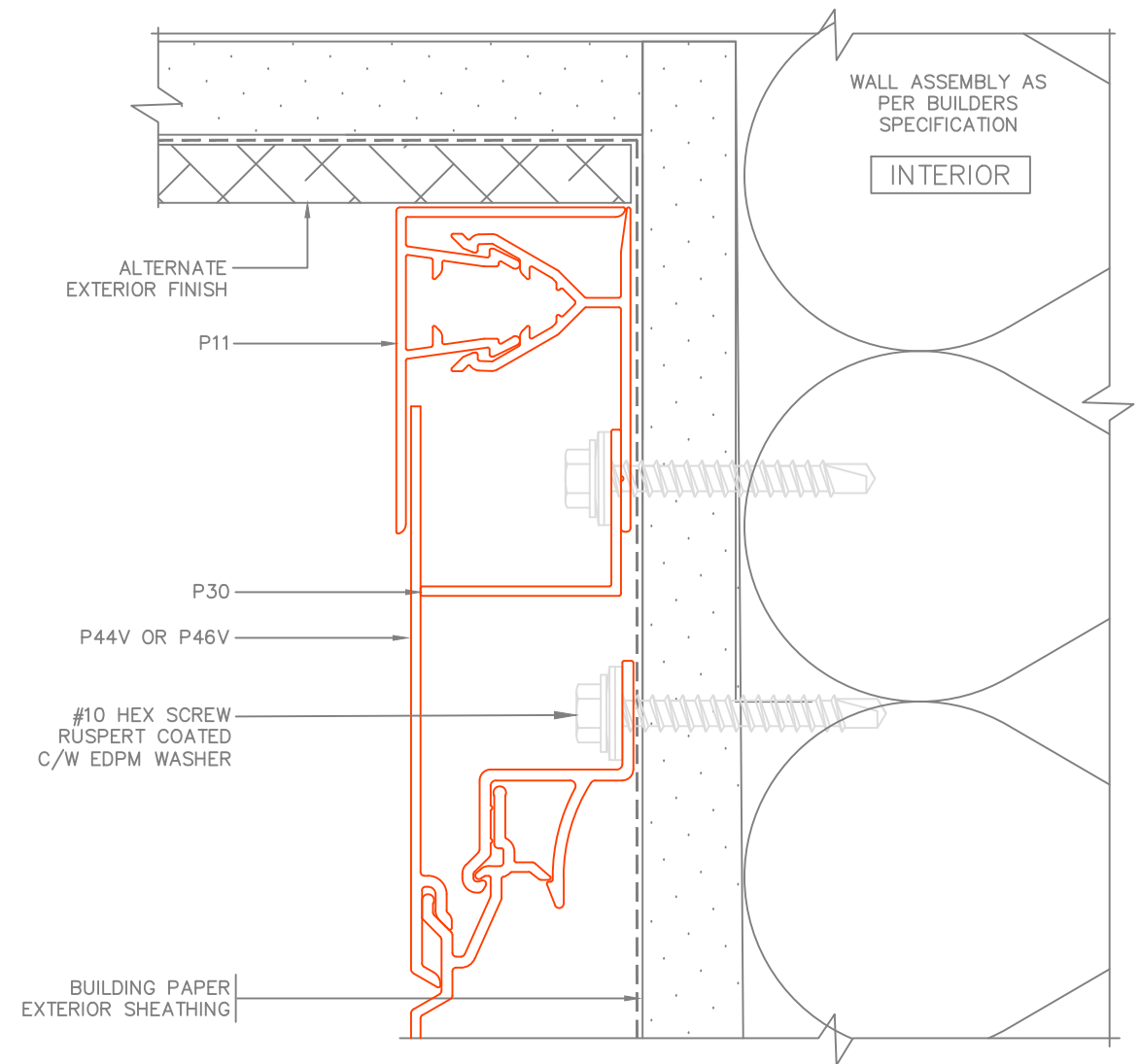

	DESCRIPTION			DRAWING NUMBER
	2-PIECE J SOFFIT TERMINATION			
	SCALE	NTS		
	DATE	FEB2024		
	DRWN BY	HJ/DDG		FP1.6b

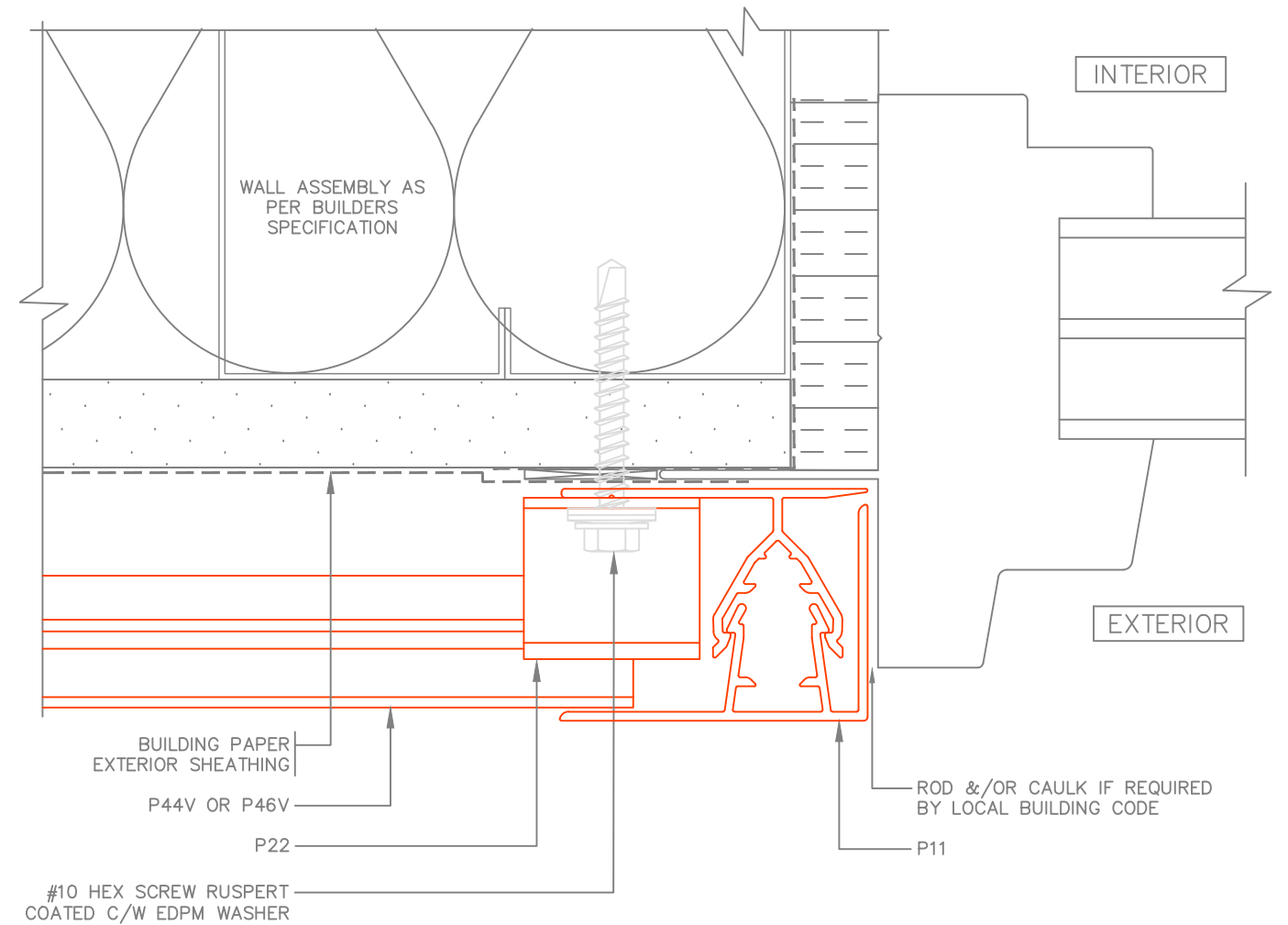

	DESCRIPTION		
	WINDOW JAMB w/ 2-PIECE J TRIM		
	SCALE	NTS	DRAWING NUMBER
	DATE	FEB2024	FP2.1
	DRWN BY	HJ/DDG	



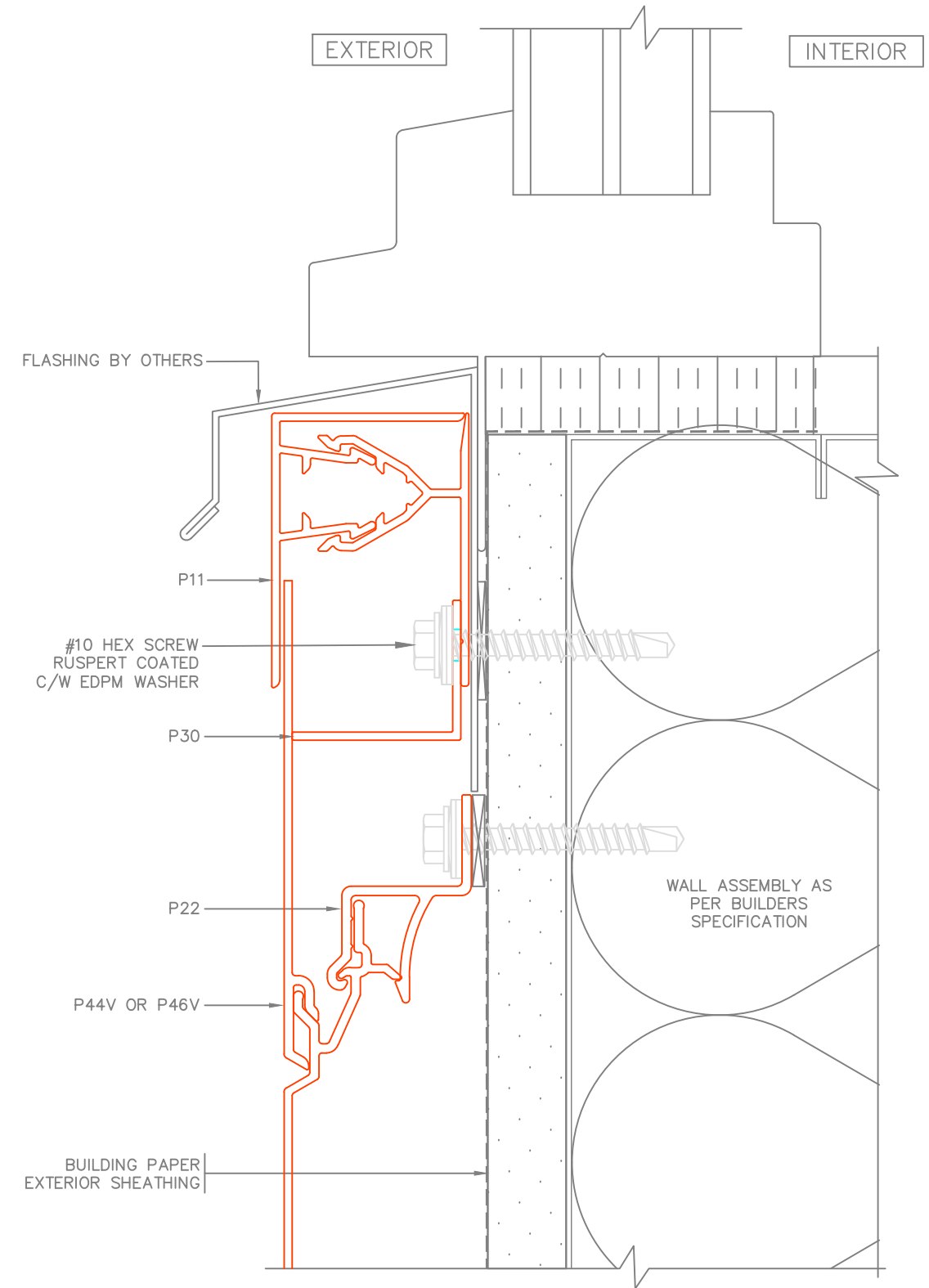
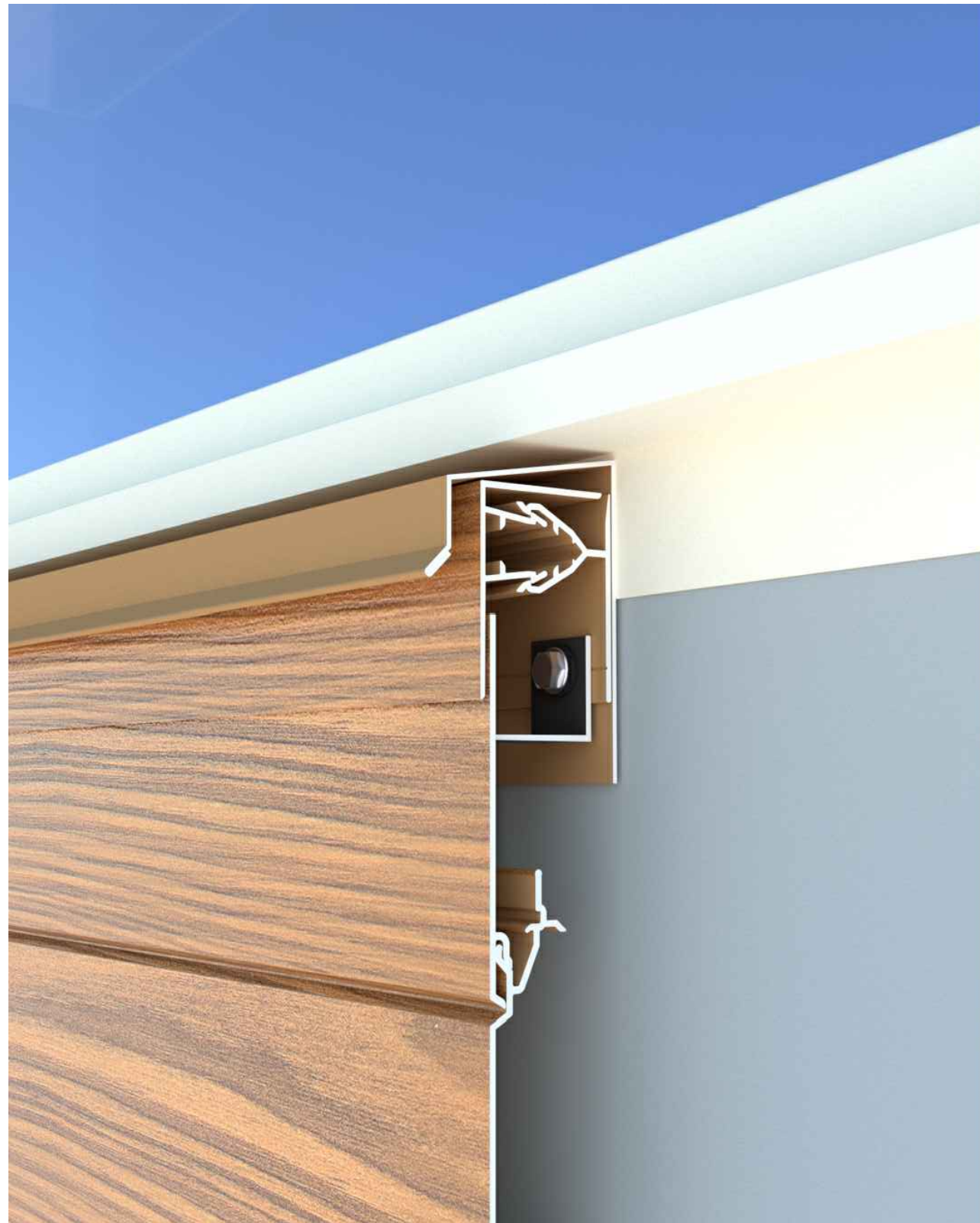

DESCRIPTION		
WINDOW SILL w/ 2-PIECE J TRIM		
SCALE	NTS	DRAWING NUMBER
DATE	FEB2024	FP2.2
DRWN BY	HJ/DDG	

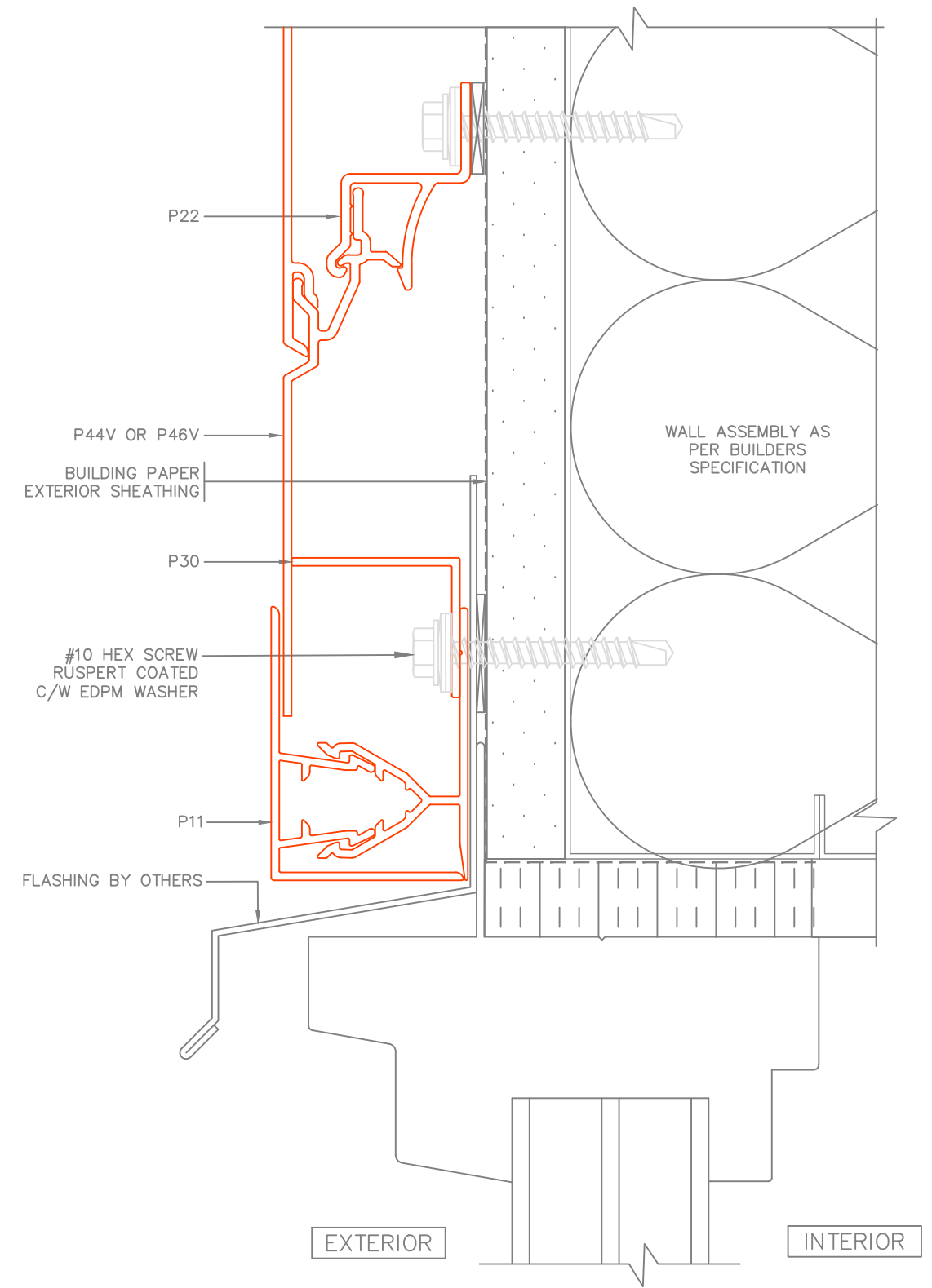

DESCRIPTION		
WINDOW HEAD w/ 2-PIECE J TRIM		
SCALE	NTS	DRAWING NUMBER
DATE	FEB2024	FP2.3
DRWN BY	HJ/DDG	

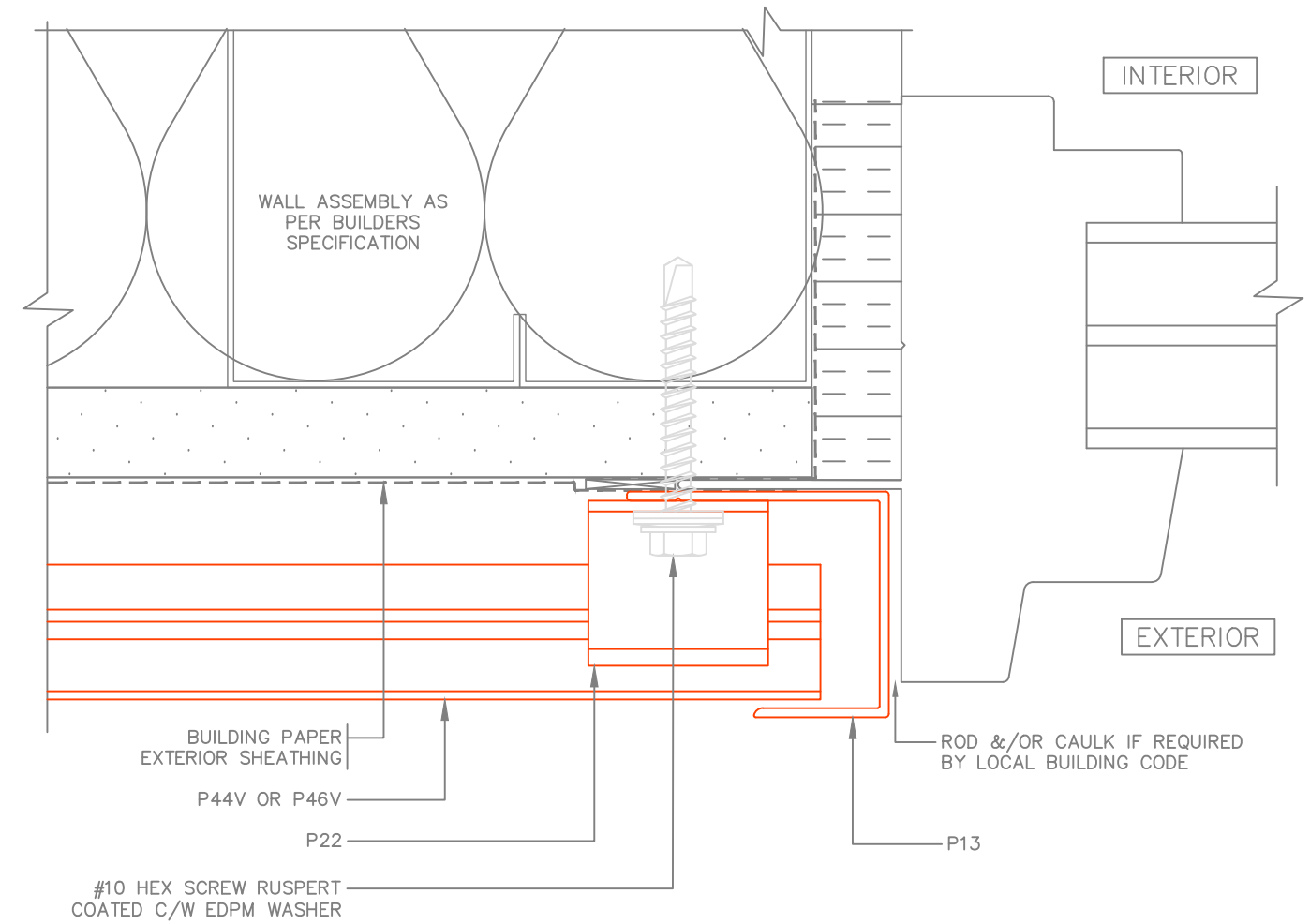
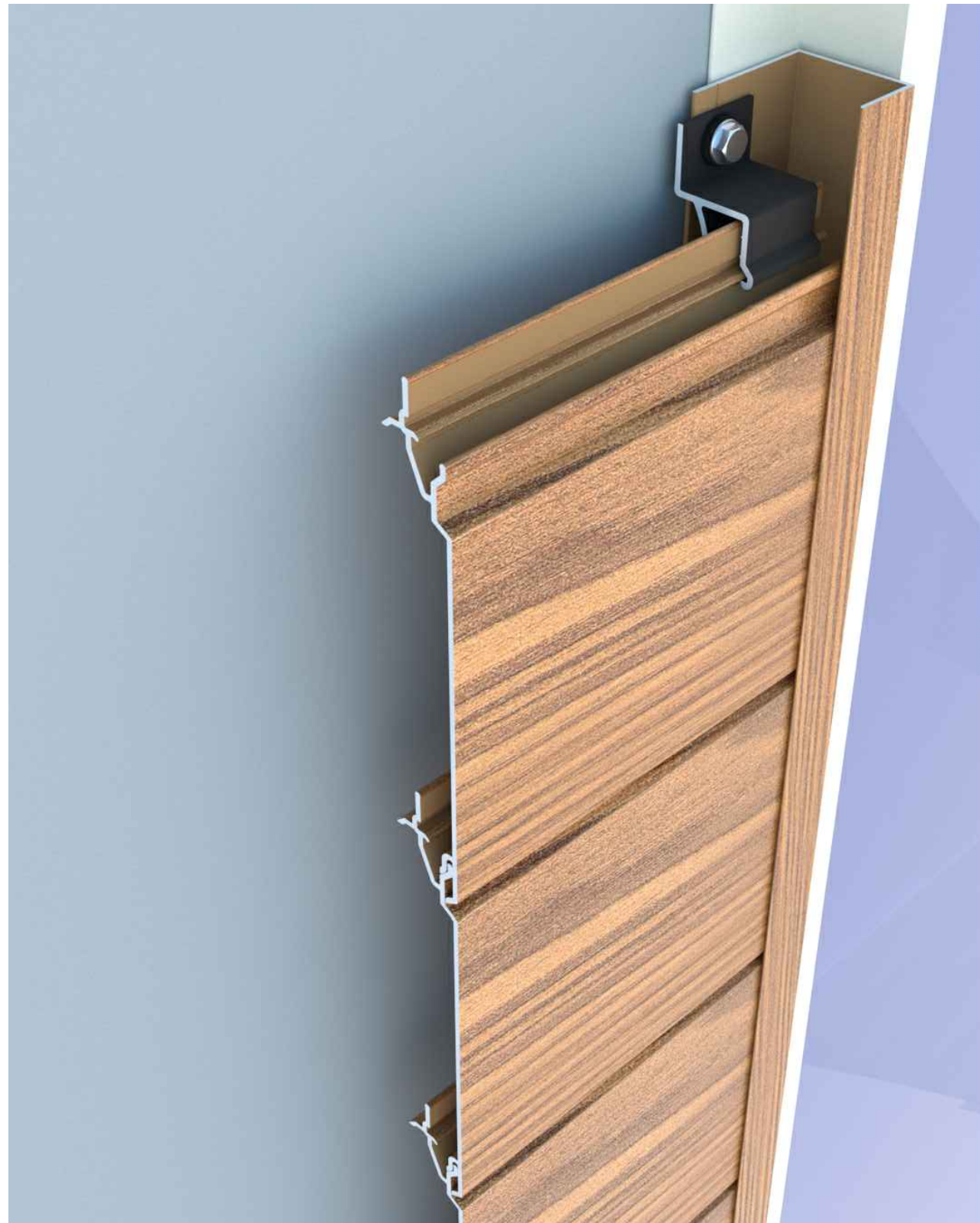

DESCRIPTION		
WINDOW JAMB w/ GENERAL J TRIM		
SCALE	NTS	DRAWING NUMBER
DATE	FEB2024	FP2.4
DRWN BY	HJ/DDG	

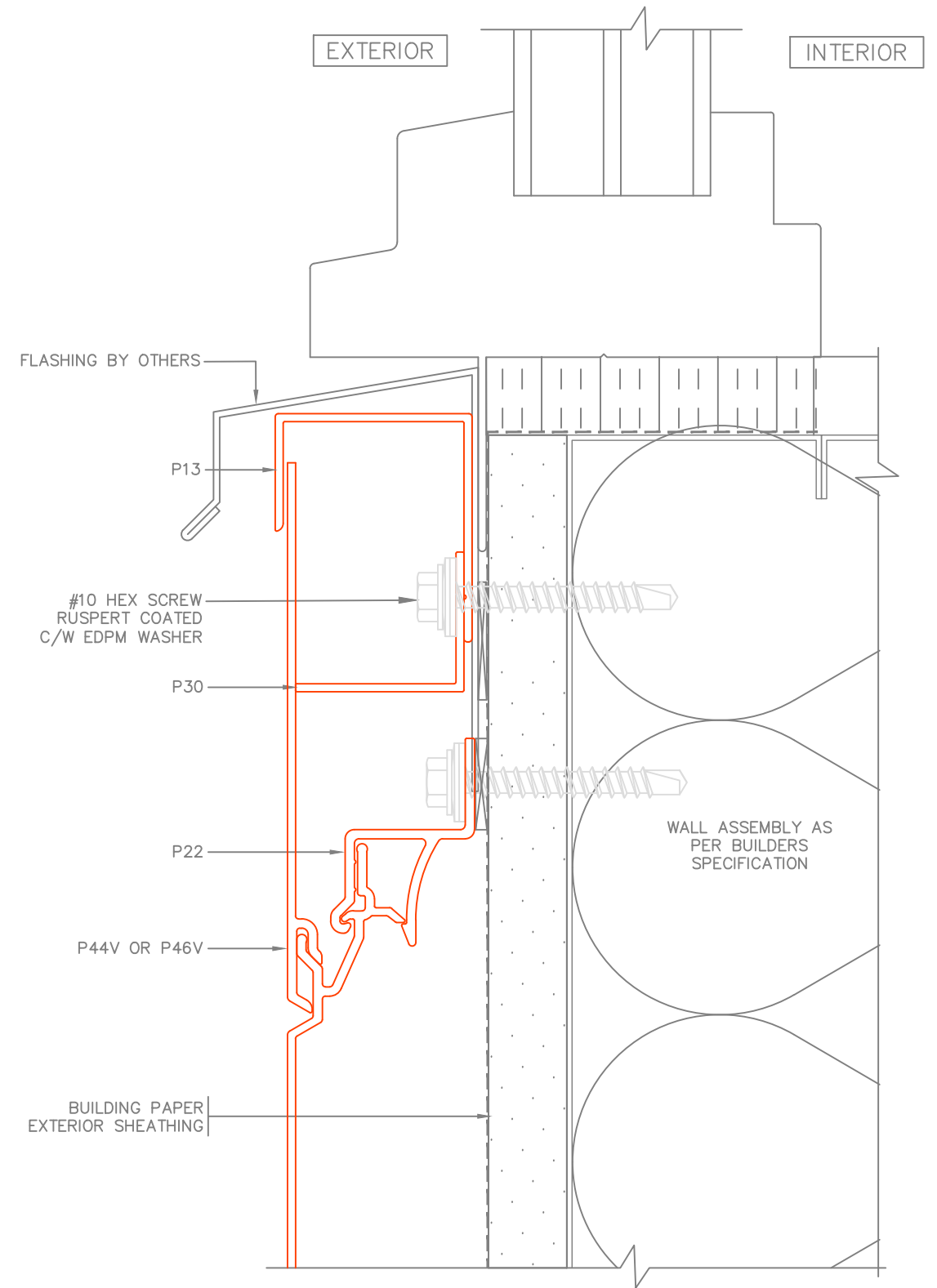
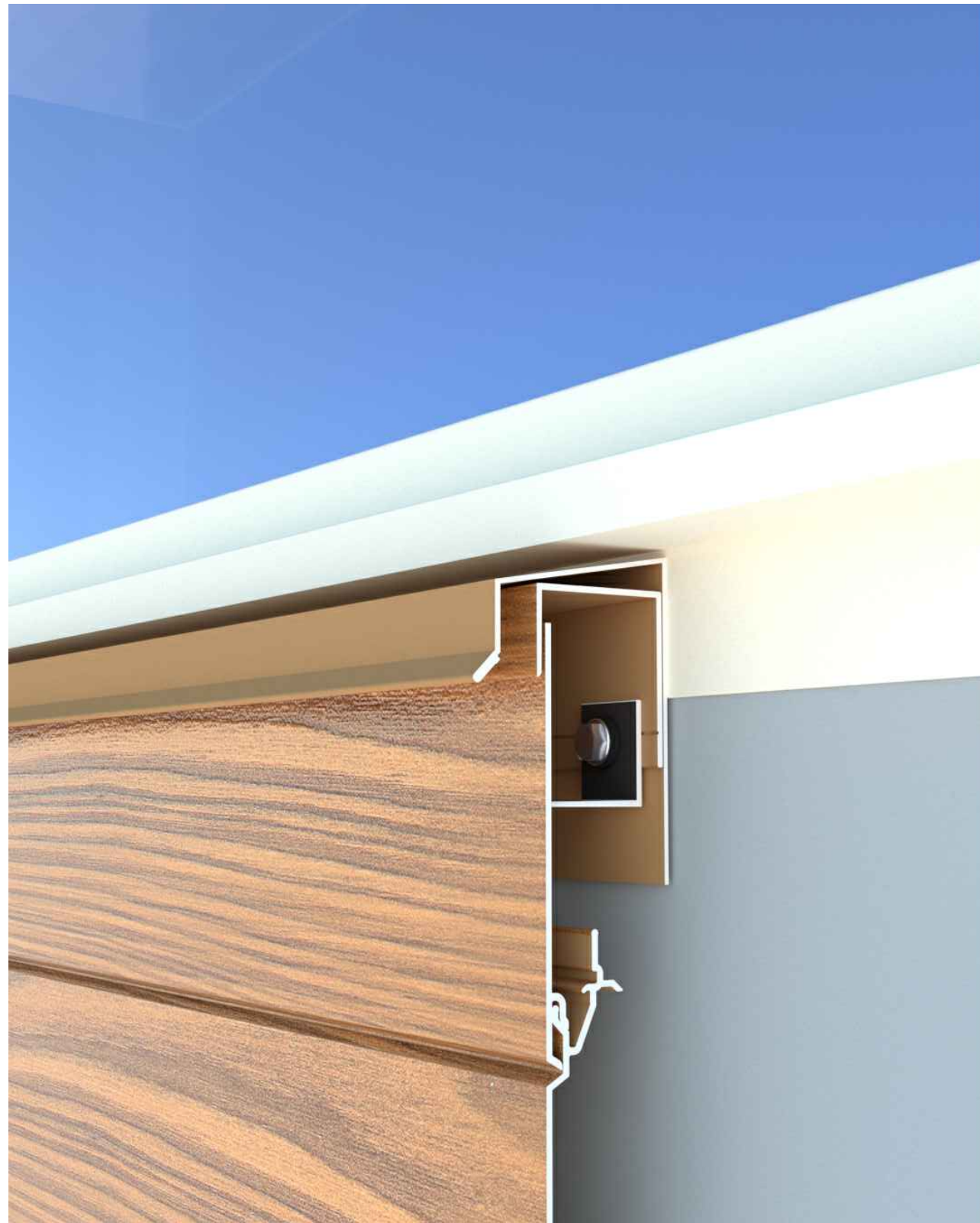

DESCRIPTION			WINDOW SILL w/ GENERAL J TRIM		
SCALE	NTS	DRAWING NUMBER			
DATE	FEB2024	FP2.5			
DRWN BY	HJ/DDG				

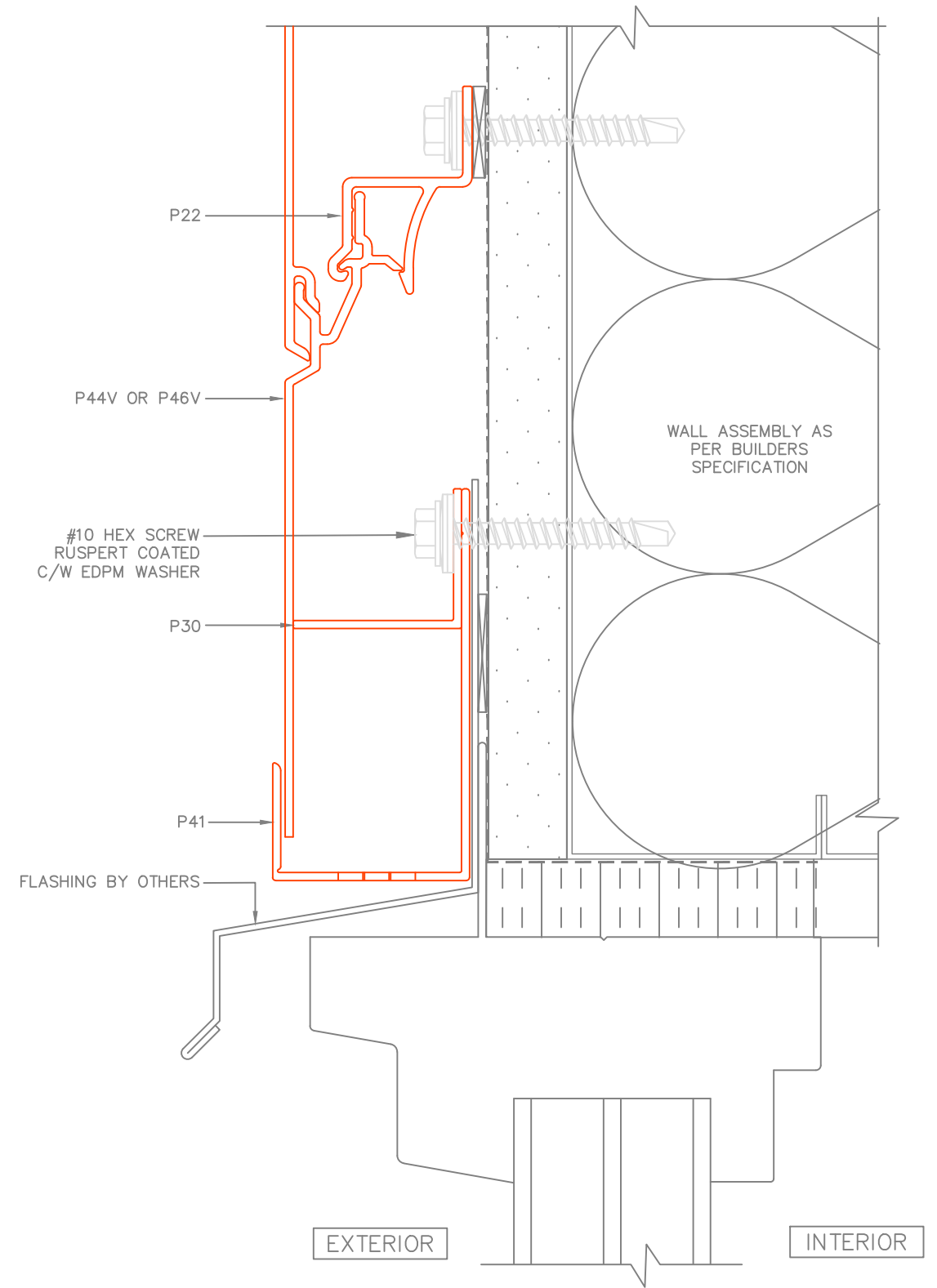
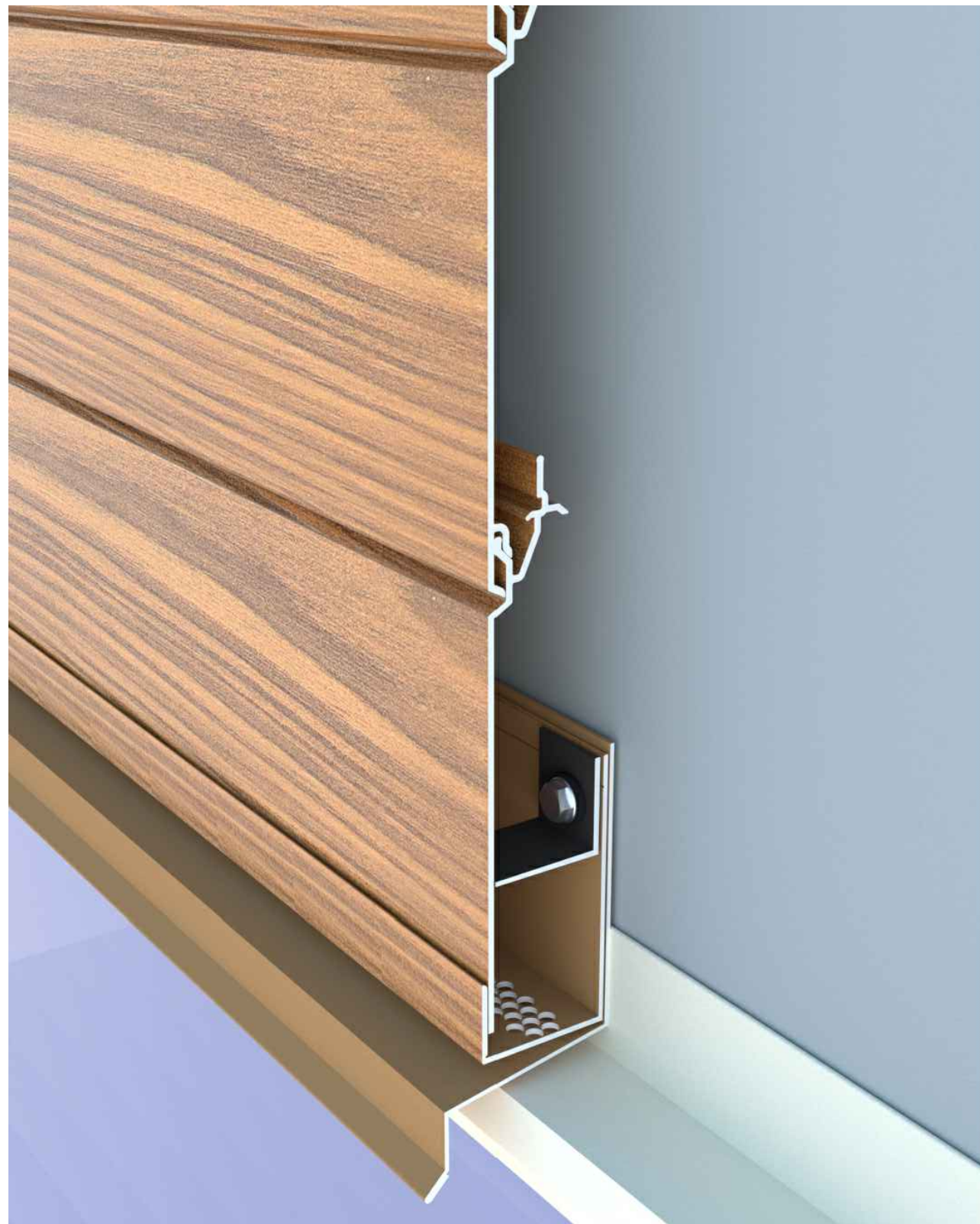

DESCRIPTION		
WINDOW HEAD w/ PERFORATED STARTER TRIM		
SCALE	NTS	DRAWING NUMBER
DATE	FEB2024	FP2.6
DRWN BY	HJ/DDG	

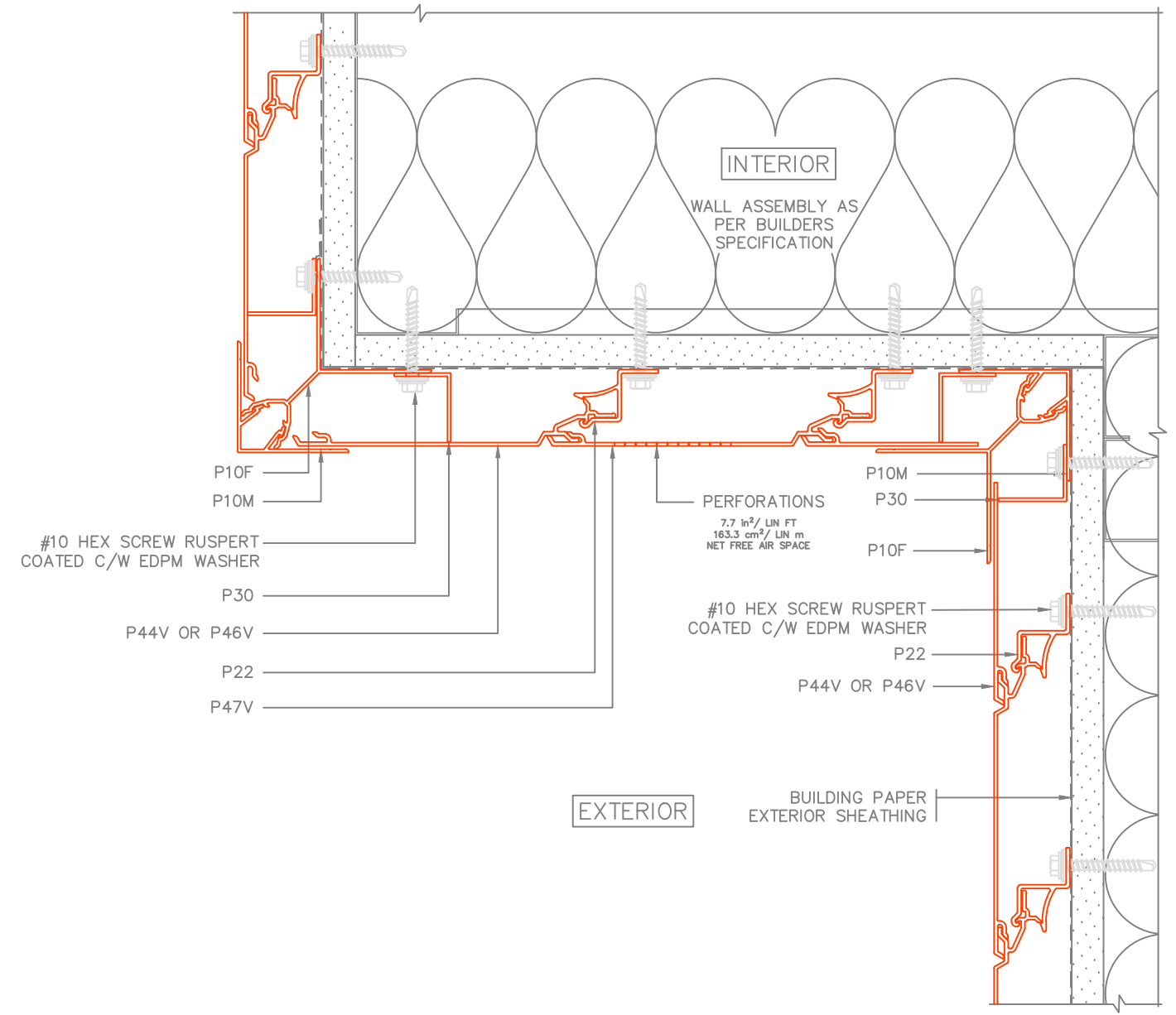
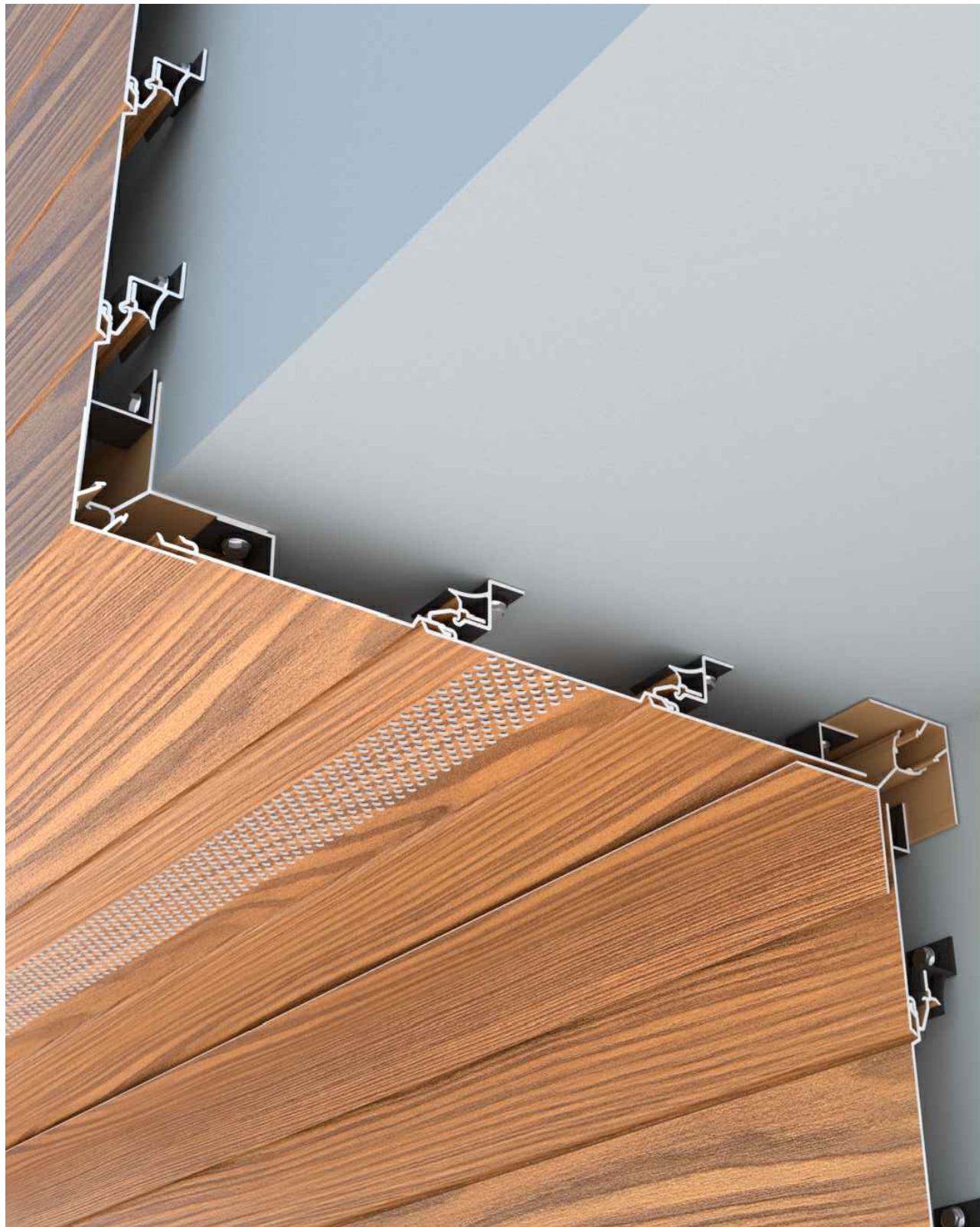

	DESCRIPTION		
	SOFFIT w/ INSIDE/OUTSIDE CORNER TRIM		
	SCALE	NTS	DRAWING NUMBER
	DATE	FEB2024	FP3.1
	DRWN BY	HJ/DDG	

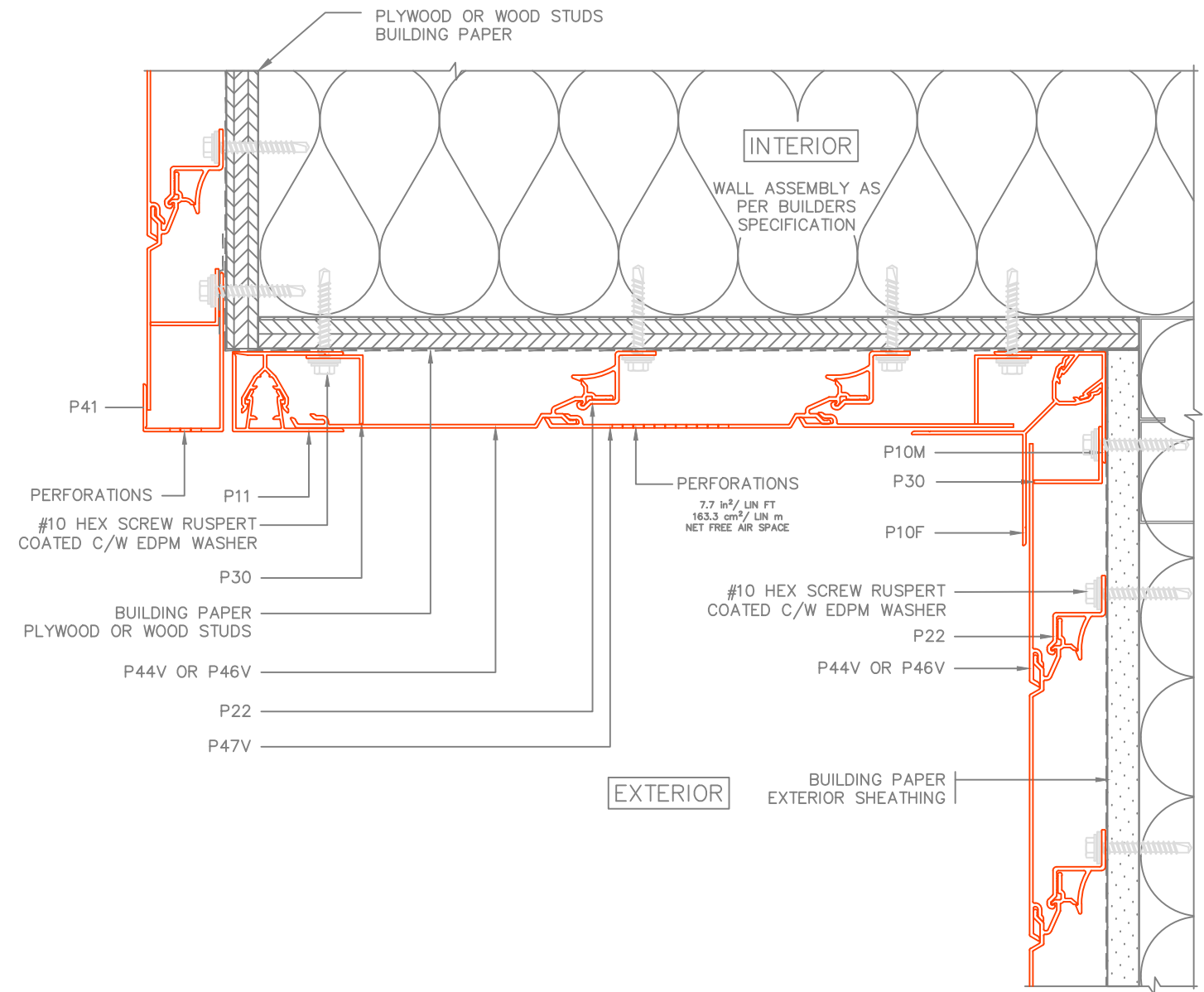
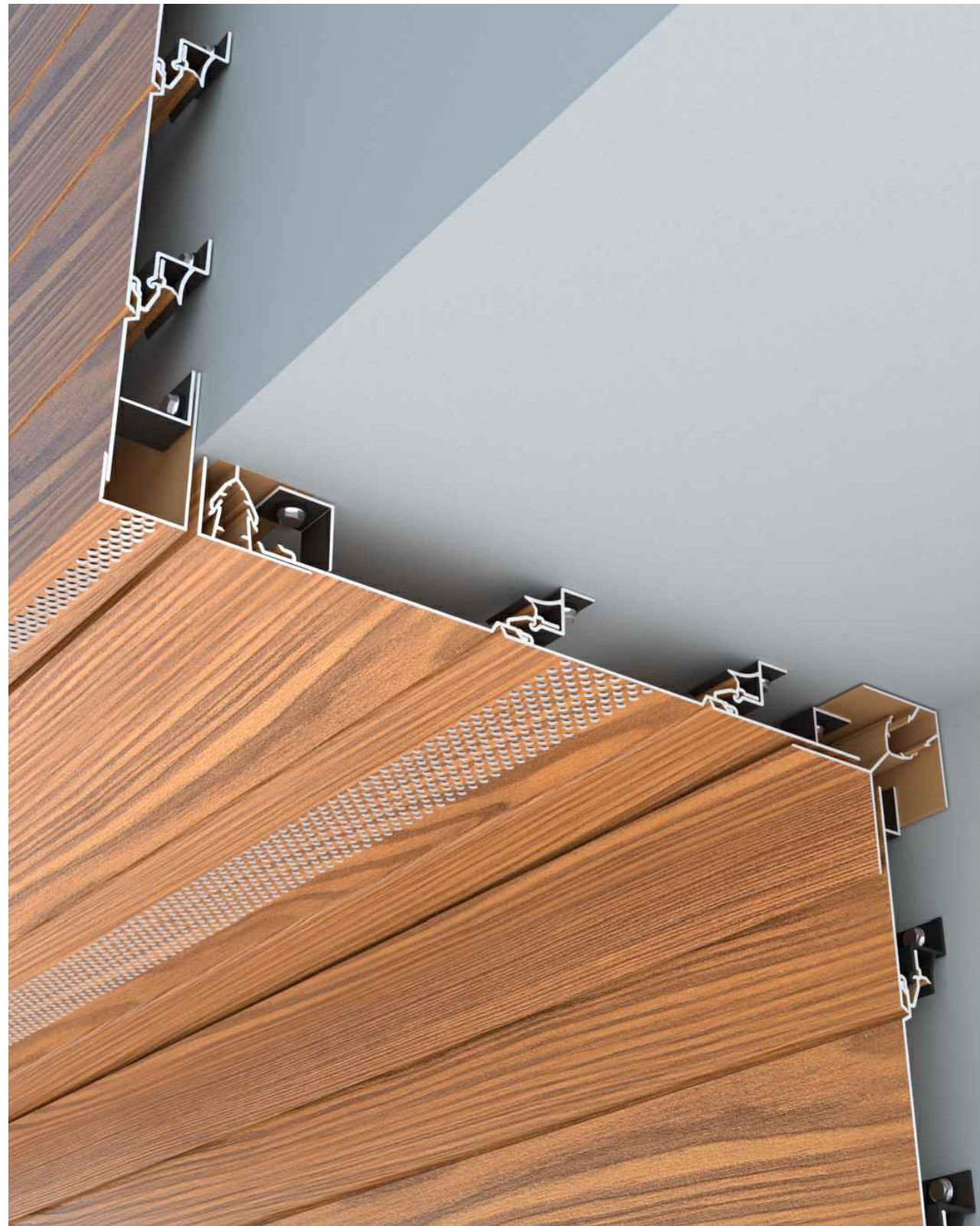

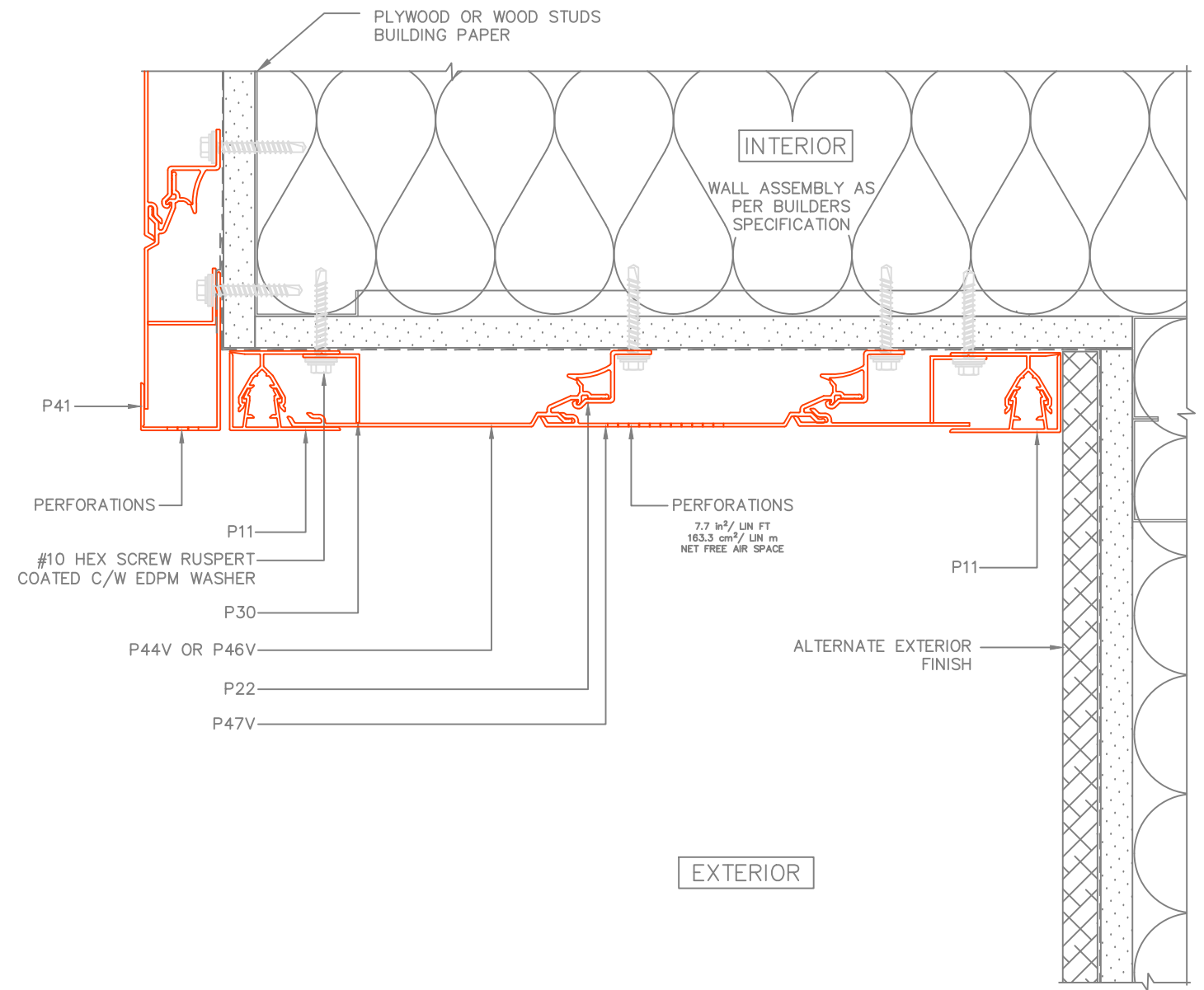
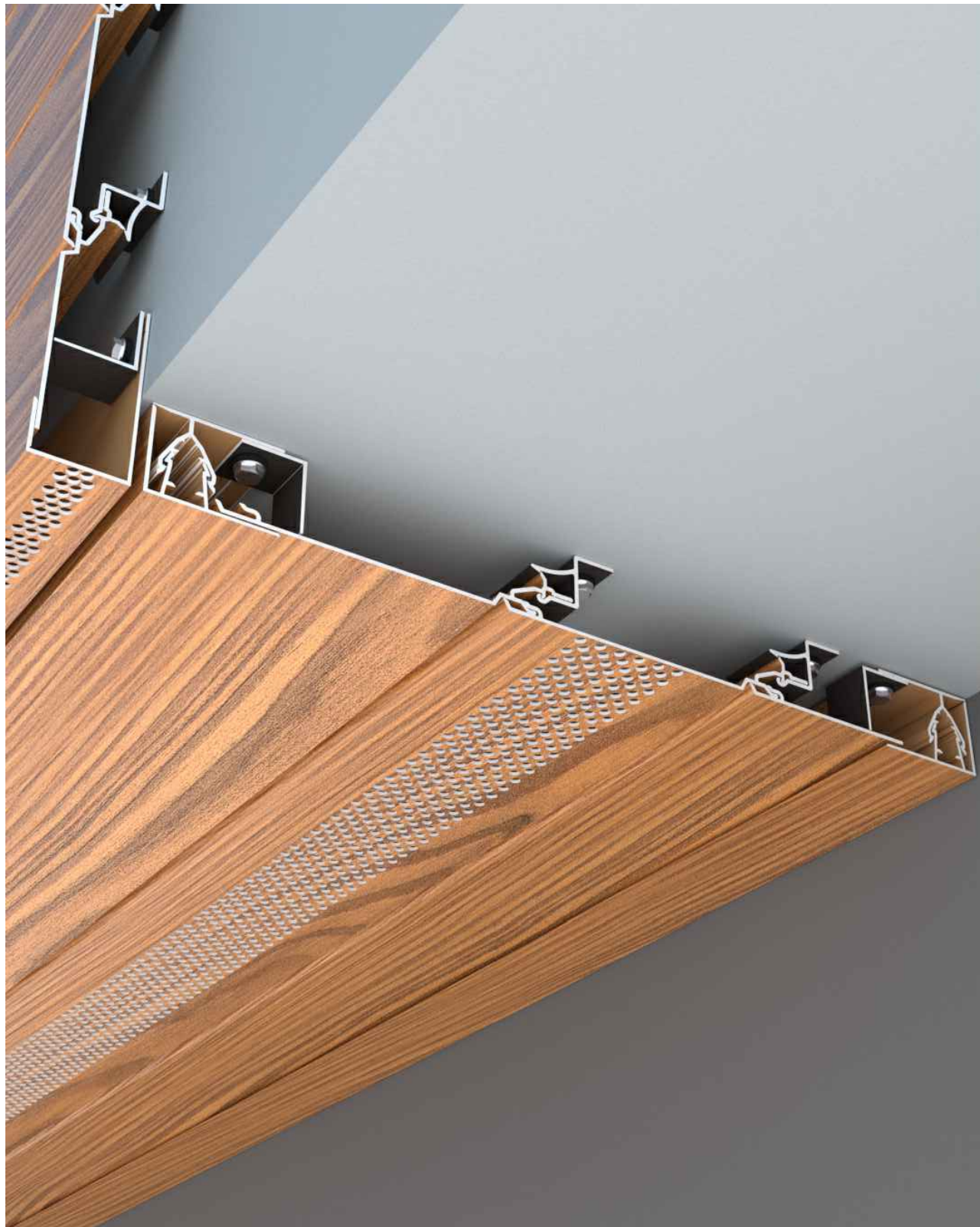

	DESCRIPTION		
	SOFFIT w/ 2-PIECE J TRIM		
	SCALE	NTS	DRAWING NUMBER
	DATE	FEB2024	FP3.3
	DRWN BY	HJ/DDG	

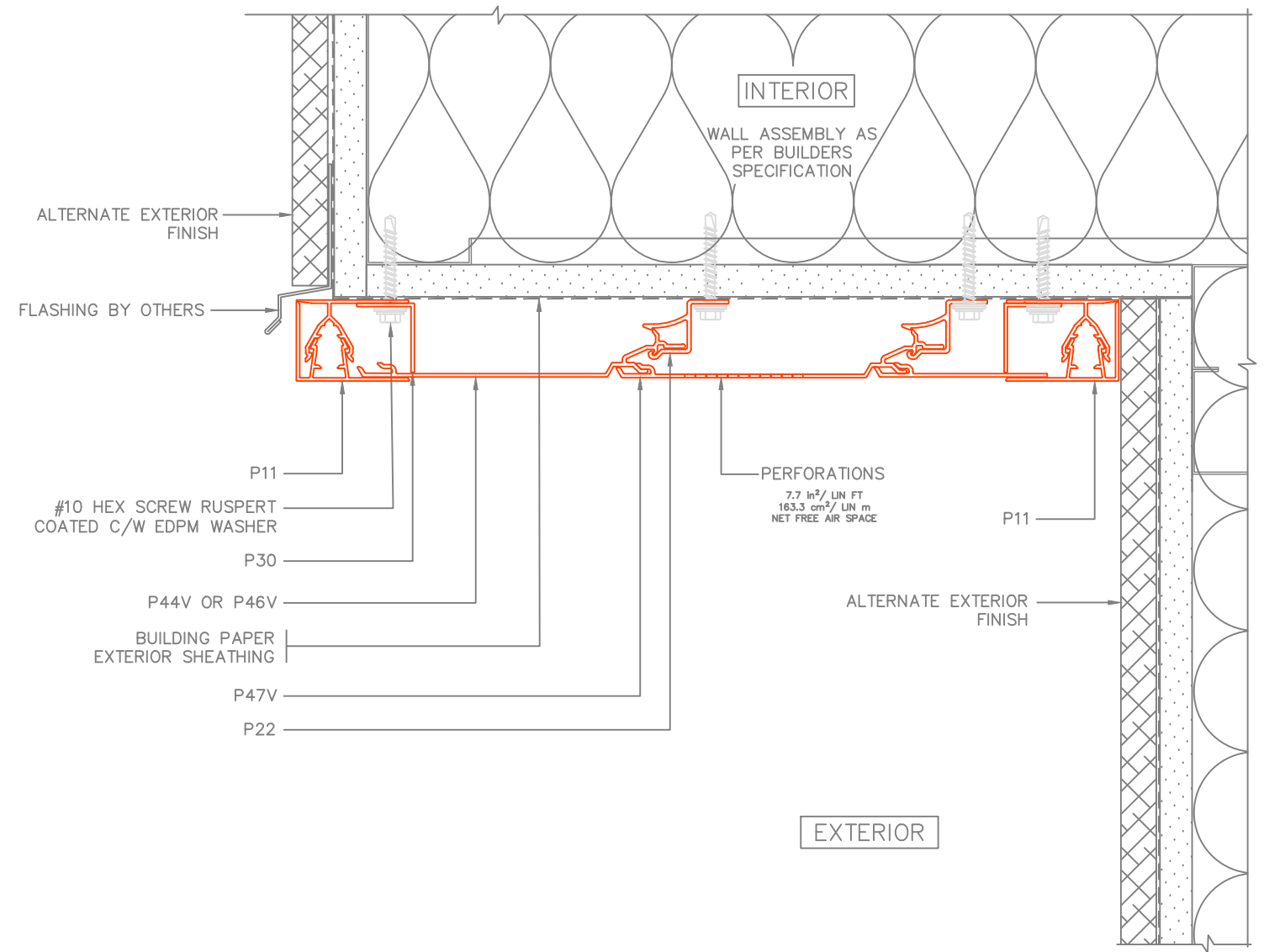
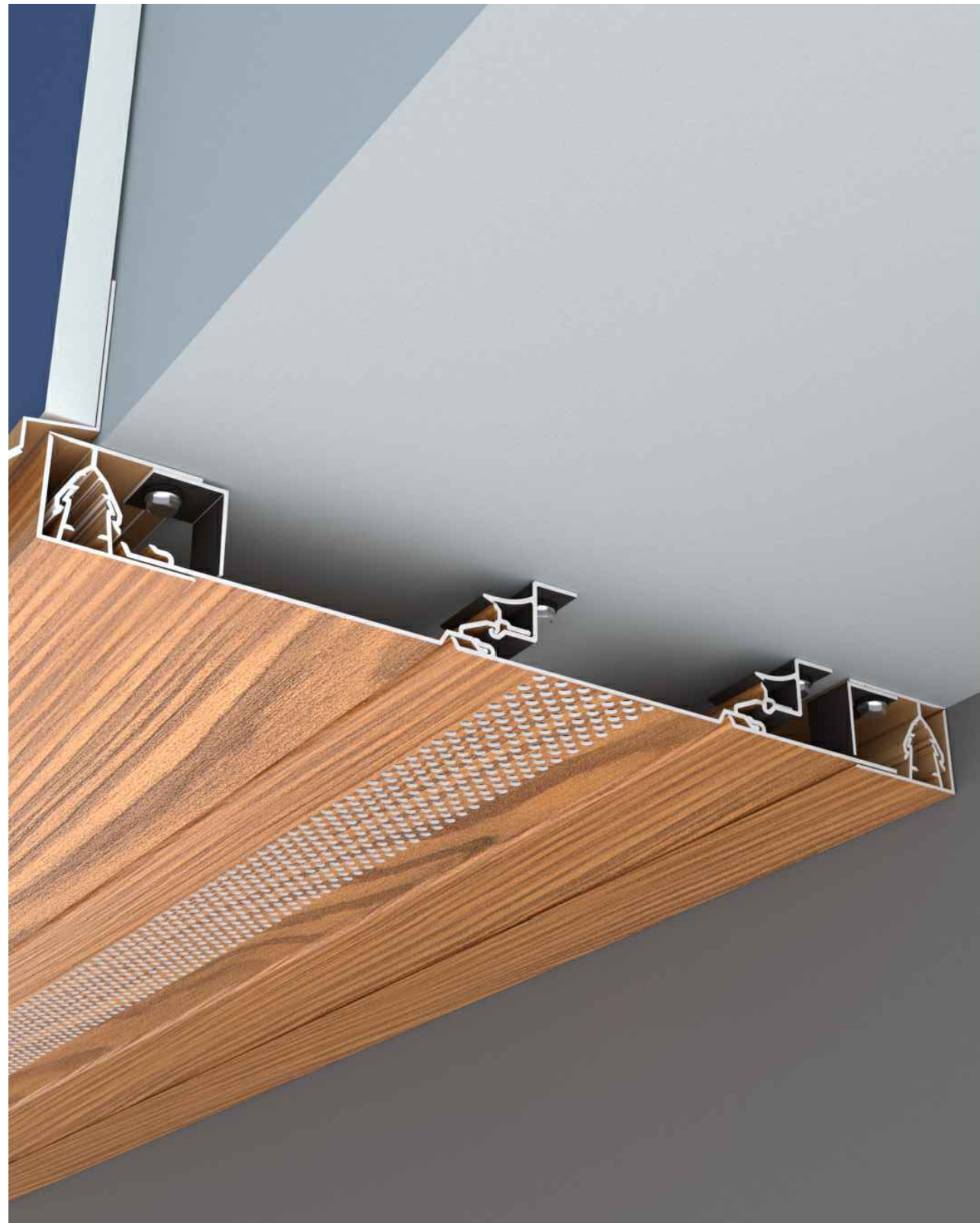

DESCRIPTION		
SOFFIT ONLY w/ 2-PIECE J TRIM		
SCALE	NTS	DRAWING NUMBER
DATE	FEB2024	FP3.4
DRWN BY	HJ/DDG	

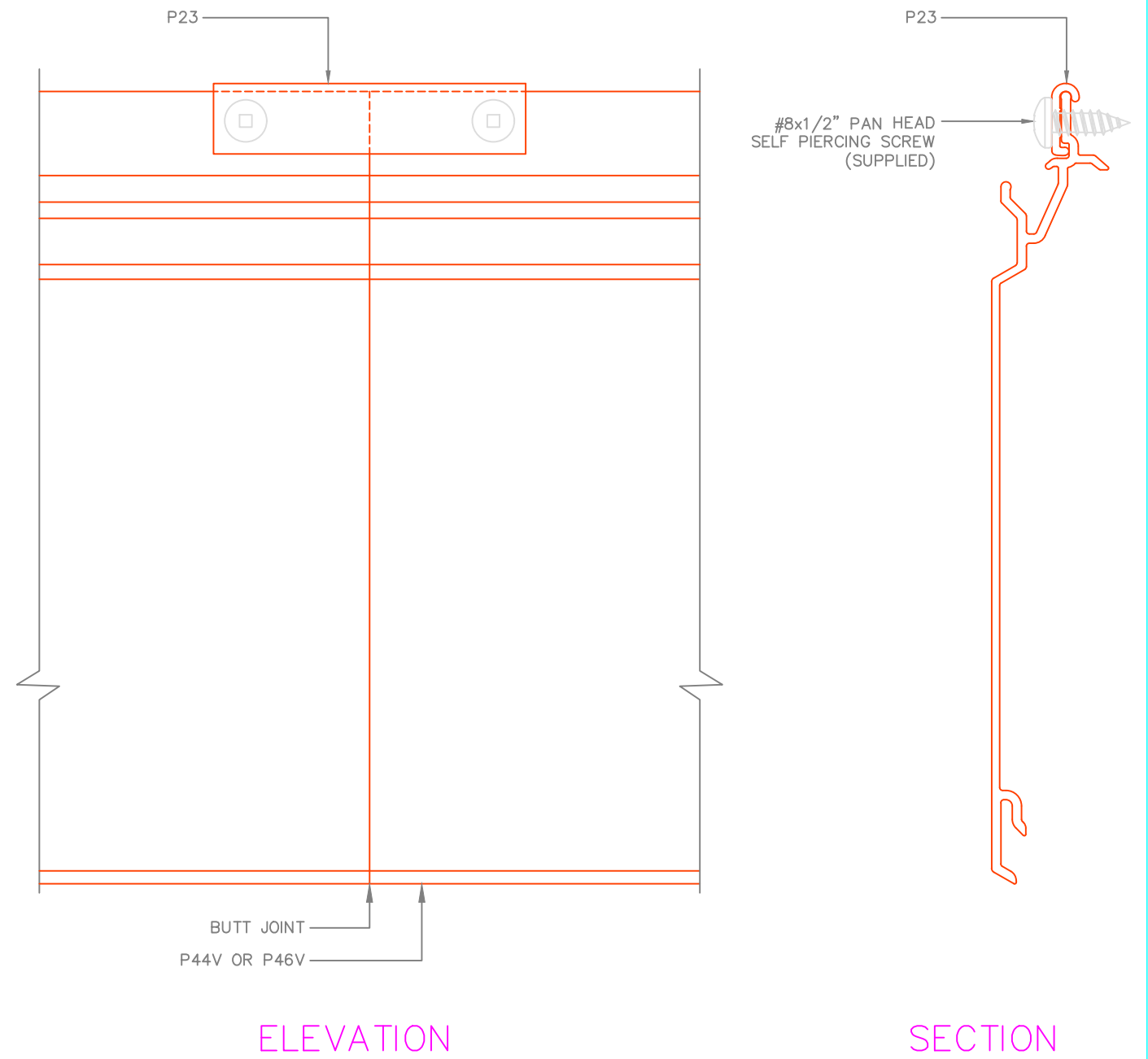

ELEVATION

SECTION

	DESCRIPTION		
	PLANK CONNECTOR @ BUTT JOINT		
	SCALE	NTS	DRAWING NUMBER
	DATE	FEB2024	FP4.1
	DRWN BY	HJ/DDG	

